



## CRIMPING PARAMETERS CHART



Parametri di pressatura







# BRAIDED HOSES



## Tubi trecciati



NOMINAL BORE	DN	5	6	8	10	12	16	19	25	31	38	51
INTERNAL DIAMETER	inches	3/16"	1/4"	5/16"	3/8"	1/2"	5/8"	3/4"	1"	1.1/4"	1.1/2"	2"
	mm	4.8	6.4	7.9	9.5	12.8	16	19	25.4	31.8	38.1	50.8



		.03	.04	.05	.06	.08	.10	.12	.16	.20	.24	.32	
<b>TEKNO/1SN</b> EN 853 1SN - SAE100 R1AT  (scelta consigliata) (recommended option) Nota / Note :  	<b>B12T..N</b> FOR STANDARD FITTINGS	16.0	18.0	18.6	20.5	23.4	27.0	30.8	39.1	48.5	57.0	69.4	
		n.s.	n.s.	n.s.	n.s.	n.s.	n.s.	n.s.	n.s.	n.s.	n.s.	n.s.	
	<b>B1SC</b> FOR STANDARD FITTINGS		16.0	17.8	20.0	23.6	27.4	30.2	37.9				
			n.s.	n.s.	n.s.	n.s.	n.s.	n.s.	n.s.				
	<b>B1T</b> FOR STANDARD FITTINGS	15.4	16.4	18.2	20.1	24.2	26.4	30.8	38.9	46.6	54.2		
		n.s.	n.s.	n.s.	n.s.	n.s.	n.s.	n.s.	n.s.	n.s.	n.s.		
	<b>B12T</b> FOR STANDARD FITTINGS					23.5	26.4	30.8					
						n.s.	n.s.	n.s.					

		.03	.04	.05	.06	.08	.10	.12	.16	.20	.24	.32
<b>TEKNO/2SN</b> EN 853 2SN - SAE100 R2AT  (scelta consigliata) (recommended option) Nota / Note :  	<b>B12T..N</b> FOR STANDARD FITTINGS	16.7	19.0	19.6	21.3	24.4	28.2	32.0	40.3	51.0	59.0	72.7
		n.s.	n.s.	n.s.	n.s.	n.s.	n.s.	n.s.	n.s.	n.s.	n.s.	n.s.
	<b>B2T</b> FOR STANDARD FITTINGS	15.7	18.0	20.2	21.4	25.6	28.5	32.0	41.0	50.0	57.5	
		n.s.	n.s.	n.s.	n.s.	n.s.	n.s.	n.s.	n.s.	n.s.	n.s.	
	<b>B12T</b> FOR STANDARD FITTINGS					24.4	27.2	32.0				
						n.s.	n.s.	n.s.				

		.03	.04	.05	.06	.08	.10	.12	.16	.20	.24	.32
<b>TEKNO/1ST</b> EN 853 1ST Nota / Note :  	<b>B1R..</b> FOR STANDARD FITTINGS	15.2	17.2	18.8	21.0	25.4	28.2	32.2	39.8	46.6	53.0	66.2
		18	21	22	23	25	28	34	37	43	47	62

		.03	.04	.05	.06	.08	.10	.12	.16	.20	.24	.32
<b>TEKNO/2ST</b> EN 853 2ST Nota / Note :  	<b>B2R..</b> FOR STANDARD FITTINGS	17.6	17.8	20.3	23.0	25.7	29.0	33.5	41.2	50.8	56.7	69.5
		18.5	21	22	23	25	28	34	37	43	47	64







		.04	.05	.06	.08	.10	.12	.16	.20	.24	.32
<b>TEKNO/1SC</b> EXCEED AN857 1SC  (scelta consigliata) (recommended option) Nota / Note :  	<b>B1SC..</b> FOR STANDARD FITTINGS	15.3	16.8	18.6	22.5	26.4	29.2	36.9			
		n.s.	n.s.	n.s.	n.s.	n.s.	n.s.	*3			
	<b>B1K</b> FOR STANDARD FITTINGS	15.0	16.3	18.6	22.7	26.4	29.5	37.9	44.8	51.3	64.6
		n.s.	n.s.	n.s.	n.s.	n.s.	n.s.	n.s.	n.s.	n.s.	n.s.

		.04	.05	.06	.08	.10	.12	.16	.20	.24	.32
<b>TEKNO/2SC</b> EXCEED AN857 2SC  (scelta consigliata) (recommended option) Nota / Note :  	<b>B12T..N</b> FOR STANDARD FITTINGS	18.2	19.0	20.6	23.5	27.4	31.1	39.1	48.7	56.2	71.0
		n.s.	n.s.	n.s.	n.s.	n.s.	n.s.	n.s.	n.s.	n.s.	n.s.
	<b>B1SC</b> FOR STANDARD FITTINGS	16.2	18.0	20.0	23.8	27.8	30.3	37.9			
		n.s.	n.s.	n.s.	n.s.	n.s.	n.s.	n.s.			

# BRAIDED HOSES

Tubi trecciati

NOMINAL BORE	DN	5	6	8	10	12	16	19	25	31	38	51
INTERNAL DIAMETER	inches	3/16"	1/4"	5/16"	3/8"	1/2"	5/8"	3/4"	1"	1.1/4"	1.1/2"	2"
	mm	4.8	6.4	7.9	9.5	12.8	16	19	25.4	31.8	38.1	50.8

<b>TEKNO/1SC PLUS</b> EXCEED AN857 1SC Nota / Note :  	<b>B1SC</b> FOR STANDARD FITTINGS		.04	.05	.06	.08	.10	.12	.16			
		15.3	16.8	18.6	22.5	26.4	29.2	36.9				
	<b>B1K</b> FOR STANDARD FITTINGS		.04	.05	.06	.08	.10	.12	.16	.20	.24	.32
15.0		16.3	18.6	22.7	26.4	29.5	37.9	44.8	50.8	64.6		
<b>TEKNO/2SC PLUS</b> EXCEED AN857 2SC (scelta consigliata) (recommended option)  Nota / Note :  	<b>B12T..N</b> FOR STANDARD FITTINGS		.04	.05	.06	.08	.10	.12	.16	.20	.24	.32
		18.2	19.0	20.6	23.5	27.4	31.1	39.1	48.7	56.2	71.0	
	<b>B1SC</b> FOR STANDARD FITTINGS		.04	.05	.06	.08	.10	.12	.16			
16.2		18.0	20.0	23.8	27.8	30.3	37.9					
<b>FORTHREE</b>	<b>B2R</b> FOR STANDARD FITTINGS		.04		.06	.08	.10	.12	.16			
		19.0		24.0	26.8	30.3	34.8	42.1				
	21		23	25	28	34	37					
<b>TEKNOMASTER 2SN</b>	<b>B2R</b> FOR STANDARD FITTINGS		.04	.05	.06	.08	.10	.12	.16			
		17.6	20.0	22.9	26.0	29.7	33.6	41.6				
	21	22	23	25	28	34	37					
<b>STRONGER/1</b> SAE 100 R16 (scelta consigliata) (recommended option) 	<b>B1R</b> FOR STANDARD FITTINGS	.03	.04	.05	.06	.08	.10	.12	.16	.20		
		15.4	17.3	18.6	20.5	25.2	27.4	31.0	39.0	45.7		
	<b>B12T..N</b> FOR STANDARD FITTINGS		.03	.04	.05	.06	.08	.10				
16.2		18.1	18.4	20.0	23.2	26.2						
<b>B1SC</b> FOR STANDARD FITTINGS		.04	.05	.06	.08	.10	.12	.16				
	16.1	17.6	19.5	23.4	26.6	29.0	38.1					
<b>SLIM</b> (scelta consigliata) (recommended option) 	<b>B1SC</b> FOR STANDARD FITTINGS		.04	.05	.06	.08		.12				
		15.0	16.8	18.2	21.9		28.7					
	<b>B1K</b> FOR STANDARD FITTINGS		.04	.05	.06	.08			.16			
14.3		15.7	17.3	21.7			35.3					
<b>B7R</b> FOR STANDARD FITTINGS		.03										
	12.3											

\*3 Note: Controllare con tampone No-Go diametro 19.65 mm

\*3 Note: Check with No-Go gauge diameter 19.65 mm

# BRAIDED HOSES

Tubi trecciati

NOMINAL BORE	DN	5	6	8	10	12	16	19	25	31	38	51
INTERNAL DIAMETER	inches	3/16"	1/4"	5/16"	3/8"	1/2"	5/8"	3/4"	1"	1.1/4"	1.1/2"	2"
	mm	4.8	6.4	7.9	9.5	12.8	16	19	25.4	31.8	38.1	50.8



TEKNOJACK	B12T..N FOR STANDARD FITTINGS		.04		.06							
			19.0		20.3							
			n.s.		n.s.							

LIFT-PLUS EN 81.2  (scelta consigliata) (recommended option) 	B12T..N FOR STANDARD FITTINGS									.24	.32	
										56.8	71.0	
	B1SC FOR STANDARD FITTINGS							.12	.16			
								29.2	36.4			
	B1R FOR STANDARD FITTINGS									.20		
										45.6		
B1K20 FOR STANDARD FITTINGS									.20			
									44.6			
B1T20 FOR STANDARD FITTINGS									.20			
									45.7			

SERVOCOMANDO	B1SC FOR STANDARD FITTINGS		.04	.05	.06	.08					
			15.5	17.0	18.6	22.5					
			n.s.	n.s.	n.s.	n.s.					

ALPI 3300	B1SC FOR STANDARD FITTINGS		.04	.05	.06	.08	.10	.12	.16		
			15.6	16.9	18.8	22.5	28.0	30.5	37.9		
			ns	ns	ns	ns	ns	ns	ns		

ALPI 4000  (scelta consigliata) (recommended option) 	B12T..N FOR STANDARD FITTINGS		.04	.05	.06	.08	.10	.12	.16		
				19.0	20.6	23.5	27.3	31.1	39.0		
	B1SC FOR STANDARD FITTINGS			n.s.	n.s.	n.s.	n.s.	n.s.	n.s.		
			.04	.05	.06	.08	.10	.12	.16		
		15.8	18.0	20.0	23.8	27.7	30.3	37.8			
		ns	ns	ns	ns	ns	ns	ns			

° I DIAMETRI DI PRESSATURA INDICATI SONO VALIDI ANCHE PER LE VERSIONI **FOREVER e EVERGREEN**  

° CRIMPING DIAMETERS REPORTED IN THIS DOCUMENT ARE VALID ALSO FOR **FOREVER AND EVERGREEN** VERSIONS  



# BRAIDED HOSES

## Tubi trecciati

NOMINAL BORE	DN	5	6	8	10	12	16	19	25	31	38	51
INTERNAL DIAMETER	inches	3/16"	1/4"	5/16"	3/8"	1/2"	5/8"	3/4"	1"	1.1/4"	1.1/2"	2"
	mm	4.8	6.4	7.9	9.5	12.8	16	19	25.4	31.8	38.1	50.8

<b>DOLOMITI/1SN</b> EN 853 1SN - SAE100 R1AT  (scelta consigliata) (recommended option)	<b>B12T..N</b> FOR STANDARD FITTINGS	.03	.04	.05	.06	.08	.10	.12	.16	.20	.24	.32	
		16.0	18.0	18.6	20.5	23.4	27.0	30.8	39.1	48.5	57.0	69.4	
		n.s.	n.s.	n.s.	n.s.	n.s.	n.s.	n.s.	n.s.	n.s.	n.s.	n.s.	
	<b>B1SC</b> FOR STANDARD FITTINGS		.04	.05	.06	.08	.10	.12	.16				
		16.0	17.8	20.0	23.6	27.4	30.2	37.9					
		n.s.	n.s.	n.s.	n.s.	n.s.	n.s.	n.s.					
	<b>B1T</b> FOR STANDARD FITTINGS	.03	.04	.05	.06	.08	.10	.12	.16	.20	.24		
		15.4	16.4	18.2	20.1	24.2	26.4	30.8	38.9	46.6	54.2		
		n.s.	n.s.	n.s.	n.s.	n.s.	n.s.	n.s.	n.s.	n.s.	n.s.		
	<b>B12T</b> FOR STANDARD FITTINGS					.08	.10	.12					
						23.5	26.4	30.8					
						n.s.	n.s.	n.s.					

<b>DOLOMITI/2SN</b> EN 853 2SN - SAE100 R2AT  (scelta consigliata) (recommended option)	<b>B12T..N</b> FOR STANDARD FITTINGS	.03	.04	.05	.06	.08	.10	.12	.16	.20	.24	.32	
		16.7	19.0	19.6	21.3	24.4	28.2	32.0	40.3	51.0	59.0	72.7	
		n.s.	n.s.	n.s.	n.s.	n.s.	n.s.	n.s.	n.s.	n.s.	n.s.	n.s.	
	<b>B2T</b> FOR STANDARD FITTINGS	.03	.04	.05	.06	.08	.10	.12	.16	.20	.24		
		15.7	18.0	20.2	21.4	25.6	28.5	32.0	41.0	50.0	57.5		
		n.s.	n.s.	n.s.	n.s.	n.s.	n.s.	n.s.	n.s.	n.s.	n.s.		
	<b>B12T</b> FOR STANDARD FITTINGS					.08	.10	.12					
						24.4	27.2	32.0					
						n.s.	n.s.	n.s.					

<b>DOLOMITI/1SC</b> EXCEED AN857 1SC  (scelta consigliata) (recommended option)	<b>B1SC..</b> FOR STANDARD FITTINGS	.04	.05	.06	.08	.10	.12	.16					
		15.3	16.8	18.6	22.5	26.4	29.2	36.9					
		n.s.	n.s.	n.s.	n.s.	n.s.	n.s.	*3					
	<b>B1K</b> FOR STANDARD FITTINGS	.04	.05	.06	.08	.10	.12	.16	.20	.24	.32		
		15.0	16.3	18.6	22.7	26.4	29.5	37.9	44.8	50.8	64.6		
		n.s.	n.s.	n.s.	n.s.	n.s.	n.s.	n.s.	n.s.	n.s.	n.s.		

<b>DOLOMITI/2SC</b> EXCEED AN857 2SC  (scelta consigliata) (recommended option)	<b>B12T..N</b> FOR STANDARD FITTINGS	.04	.05	.06	.08	.10	.12	.16	.20	.24	.32	
		18.2	19.0	20.6	23.5	27.4	31.1	39.1	48.7	56.2	71.0	
		n.s.	n.s.	n.s.	n.s.	n.s.	n.s.	n.s.	n.s.	n.s.	n.s.	
	<b>B1SC</b> FOR STANDARD FITTINGS	.04	.05	.06	.08	.10	.12	.16				
		16.2	18.0	20.0	23.8	27.8	30.3	37.9				
		n.s.	n.s.	n.s.	n.s.	n.s.	n.s.	n.s.				

# SPIRAL HOSES

Tubi spiralati

	NOMINAL BORE	DN	5	6	8	10	12	16	19	25	31	38	51		
			INTERNAL DIAMETER	inches	3/16"	1/4"	5/16"	3/8"	1/2"	5/8"	3/4"	1"	1.1/4"	1.1/2"	2"
				mm	4.8	6.4	7.9	9.5	12.8	16	19	25.4	31.8	38.1	50.8
<b>TEKNOSPIR/4SP</b> EN856 4SP  (impieghi severi) (severe applications)	B9R FOR STANDARD FITTINGS			.04		.06	.08	.10	.12	.16	.20	.24	.32		
				19.2		23.2	26.3	29.8	33.5	41.8	54.6	58.5	74.6		
				21		23	27	31	36	48	54	62	64		
	KB4SH FOR INTERLOCK FITTINGS									.12	.16				
										33.9	41.5				
										15 in. 52 out.	17 in. 67 out.				
	B5K FOR STANDARD FITTINGS					.06	.08	.10	.12	.16	B5K206				
						25.8	28.5	32.9	36.0	43.5	57.0				
						n.s.	n.s.	n.s.	n.s.	n.s.	n.s.				
	HB4NS FOR HYPERSPIRAL FITTINGS					.06	.08	.10	.12	.16					
						26.1	28.8	33.9	37.5	46.5					
						n.s.	n.s.	n.s.	n.s.	n.s.					
	HB6NS FOR HYPERSPIRAL FITTINGS											.20	.24		
												58.3	coming soon		
												n.s.	n.s.		

<b>TEKNOSPIR/4SH</b> EN856 4SH  (impieghi severi) (severe applications)	KB4SH FOR INTERLOCK FITTINGS							.10	.12	.16	.20	.24	.32	
	B4SH FOR STANDARD FITTINGS											.20	.24	.32
												48.0	58.0	70.5
												54	62	64
	B5K FOR STANDARD FITTINGS								.12	.16	B5K204			
									36.0	43.7	54.0			
									n.s.	n.s.	n.s.			
	HB4NS FOR HYPERSPIRAL FITTINGS								.10	.12	.16	.20	.24	
									35.2	37.5	46.7	55.5	63.1	
									n.s.	n.s.	n.s.	n.s.	n.s.	

° I DIAMETRI DI PRESSATURA INDICATI SONO VALIDI ANCHE PER LE VERSIONI

**ICEBERG / FOREVER / EVERGREEN**



° CRIMPING DIAMETERS REPORTED IN THIS DOCUMENT ARE VALID ALSO FOR



**ICEBERG / FOREVER / EVERGREEN VERSIONS**





# SPIRAL HOSES

Tabi spiralati

NOMINAL BORE	DN	5	6	8	10	12	16	19	25	31	38	51
INTERNAL DIAMETER	inches	3/16"	1/4"	5/16"	3/8"	1/2"	5/8"	3/4"	1"	1.1/4"	1.1/2"	2"
	mm	4.8	6.4	7.9	9.5	12.8	16	19	25.4	31.8	38.1	50.8

<p><b>TEKNOSPIR/12</b> EN856 R12 SAE 100 R12</p> <p>Nota / Note :  </p>	B9R FOR STANDARD FITTINGS					.06	.08	.10	.12	.16	.20	.24		
							23.0	26.5	30.4	34.0	41.9	52.9	58.5	
							23	27	31	36	48	54	62	
	B4SH FOR STANDARD FITTINGS												.24	.32
													58.9	70.6
													62	64
	B5K FOR STANDARD FITTINGS						.06	.08	.10	.12	.16	B5K206		
							26.2	27.6	32.3	35.8	43.5	57.0		
							n.s.	n.s.	n.s.	n.s.	n.s.	n.s.		
	HB4NS FOR HYPERSPIRAL FITTINGS						.06	.08	.10	.12	.16			
							26.1	29.0	33.5	37.3	46.5			
							n.s.	n.s.	n.s.	n.s.	n.s.			
HB6NS FOR HYPERSPIRAL FITTINGS											.20	.24		
											58.3	coming soon		
											n.s.	n.s.		

<p><b>TEKNOSPIR/13</b> EN856 R12 SAE 100 R13</p> <p>Nota / Note :  </p>	KB4SH FOR INTERLOCK FITTINGS								.12	.16	.20			
										34.7	42.2	49.8		
										15 in. 52 out.	17 in. 67 out.	21.5 in. 74 out.		
	KBH13 FOR INTERLOCK FITTINGS												.24	.32
													59.7	78.2
													22 in. 81 out.	29 in. 85 out.
	HB4NS FOR HYPERSPIRAL FITTINGS									.12	.16	.20		
										37.5	46.5	55.5		
										n.s.	n.s.	n.s.		

<p><b>TEKNOSPIR/15</b> EN856 R12 SAE 100 R15</p> <p>Nota / Note :  </p>	KB4SH FOR INTERLOCK FITTINGS								.12	.16				
										33.9	41.5			
										15 in. 52 out.	17 in. 67 out.			
	KBH13 FOR INTERLOCK FITTINGS											.20	.24	.32
												54.6	61.3	77.4
												21.5 in. 74 out.	22 in. 81 out.	29 in. 85 out.
	HB4NS FOR HYPERSPIRAL FITTINGS								.10	.12	.16			
										34.5	37.5	46.7		
										n.s.	n.s.	n.s.		
	HB6NS FOR HYPERSPIRAL FITTINGS											.20		
												57.8		
												n.s.		





# SPIRAL HOSES

Tubi spiralati

NOMINAL BORE	DN	5	6	8	10	12	16	19	25	31	38	51
INTERNAL DIAMETER	inches	3/16"	1/4"	5/16"	3/8"	1/2"	5/8"	3/4"	1"	1.1/4"	1.1/2"	2"
	mm	4.8	6.4	7.9	9.5	12.8	16	19	25.4	31.8	38.1	50.8

EVEREST/6000	KB4SH FOR INTERLOCK FITTING								.12	.16				
										33.9	41.3			
										15 in. 52 out.	17 in. 67 out.			
	KBH13 FOR INTERLOCK FITTING										.20	.24	.32	
											53.3	60.5	coming soon	
											21.5 in. 74 out.	22 in. 81 out.	n.s.	
	HB4NS FOR HYPERSPIRAL FITTINGS					.06	.08	.10	.12	.16				
						26.1	29.0	33.7	37.5	46.7				
						n.s.	n.s.	n.s.	n.s.	n.s.				
	HB6NS FOR HYPERSPIRAL FITTINGS										.20			
											57.8			
											n.s.			
	B9R FOR STANDARD FITTINGS			.04		.06	.08	.10						
			coming soon		coming soon	coming soon	coming soon							
			n.s.		n.s.	n.s.	n.s.							

TEKNOBLAST AS/NZS 4233.2	WB4 FOR WATERBLAST-FITTINGS				.06	.08		.12					
					24.4	28.2		38.6					
					15 in. 47 out.	16 in. 52 out.		19 in. 54 out.					

TEKNOBLAST PLUS AS/NZS 4233.2	WB4 FOR WATERBLAST-FITTINGS				.06	.08		.12	.16				
					24.6	29.1		38.9	41.5				
					15 in. 47 out.	16 in. 52 out.		19 in. 54 out.	17 in. 57 out.				

TEKNOBLAST SUPERB AS/NZS 4233.2	WB6 FOR WATERBLAST-FITTINGS					.08		.12					
						-		41.2					
						-		19 in. 54 out.					

Nota: Data la larga tolleranza ammessa sulle dimensioni dei tubi, le quote di pressatura espresse sono indicative, si consiglia pertanto di utilizzare sempre i tamponi passa non passa per verificare il giusto collasso del codolo.

Note: Considering the wide tolerance admitted on the hoses dimensions, the expressed crimping diameters have to be considered as approximate; therefore, it is recommended to use always the go – no go gauge in order to check the tail collapse.

## TERMOPLASTIC HOSES

HOSES	DN/DASH SIZE	0,2/-03	0,2/-04	0,3/-05	0,4/-06	0,5/-08	0,6/-10	0,7/-12	1,0/-12	1,2/-20	1,5/-24	2,0/-32
	FERRULES	3/16"	1/4"	5/16"	3/8"	1/2"	5/8"	3/4"	1"	1.1/4"	1.1/2"	2"

<b>R7*</b> THERMO-PLASTIC  * Diametri di pressatura su tubo ZEC * Crimping diameter on ZEC hose	B7R	B7R03	B7R04	B7R05	B7R06	B7R08	B7R10	B7R12	B7R16			
		11.8	14.1	16.2	18.2	22.2	25.6	29.0	36.8			
		n.s.	n.s.	n.s.	n.s.	n.s.	n.s.	n.s.	n.s.			
	B1K		B1K04	B1K05	B1K06	B1K08						
			14.0	17.0	17.6	22.8						
			n.s.	n.s.	n.s.	n.s.						

<b>R7 MTH1*</b> THERMO-PLASTIC  * Diametri di pressatura su tubo ZEC * Crimping diameter on ZEC hose	B7R	B7R03	B7R04	B7R05	B7R06	B7R08	B7R10	B7R12	B7R16			
		11.8	14.1	16.2	18.2	22.2	25.6	29.0	36.8			
		n.s.	n.s.	n.s.	n.s.	n.s.	n.s.	n.s.	n.s.			
	B1K		B1K04	B1K05	B1K06	B1K08						
			13.8	17.0	18.0	21.7						
			n.s.	n.s.	n.s.	n.s.						

## PTFE

HOSES	DN/DASH SIZE	0,2/-03	0,2/-04	0,3/-05	0,4/-06	0,5/-08	0,6/-10	0,7/-12	1,0/-16	1,2/-20	1,5/-24	2,0/-32
	FERRULES	3/16"	1/4"	5/16"	3/8"	1/2"	5/8"	3/4"	1"	1.1/4"	1.1/2"	2"

<b>PTFE</b> LISCIO (SMOOTH) 1BRAID *	BPTFE	BPTFE03	BPTFE04	BPTFE05	BPTFE06	BPTFE08	BPTFE10	BPTFE12	BPTFE16			
		11.0	13.1	14.7	16.2	20.8	22.2	27.9	34.5			
<b>PTFE</b> LISCIO (SMOOTH) 2BRAIDS *		BPTFE03	B7R04	B7R05	B7R06	BPTFE08	B7R10		B7R16			
		12.0	12.8	15.5	16.8	21.1	24.4		34.7			
<b>PTFE</b> CORRUGATO (CORRUGATED)	BPTFEC		BPTFEC04		BPTFEC06	BPTFEC08	BPTFEC10	BPTFEC12	BPTFEC16	BPTFEC20	BPTFEC24	BPTFEC32
			12.8		16.0	19.4	22.2	26.2	33.6	45.0	50.4	63
	B7R		B7R04				B7R10					
			12.8				24.3					

\* VALIDO ANCHE PER TUBO CONDUTTIVO  
(ALSO VALID FOR CONDUCTING TUBE)



## TEXTILE HOSES

<b>HOSES</b>	DN/DASH SIZE	0,2/-03	0,2/-04	0,3/-05	0,4/-06	0,5/-08	0,6/-10	0,7/-12	1,0/-12	1,2/-20	1,5/-24	2,0/-32	
	FERRULES	3/16"	1/4"	5/16"	3/8"	1/2"	5/8"	3/4"	1"	1.1/4"	1.1/2"	2"	
1TE/R6	B7R		B7R04	B7R05	B7R06	B7R08	B7R10	B7R12					
			15.0	16.6	18.4	22.6	26.1	29.3					
	B1K		B1K04	B1K05	B1K06	B1K08	B1K10	B1K12	B1K16				
			15.2	16.7	18.1	22.2	26.7	29.8	36.8				
B1T	B1T03												
		15.2											
B6R	B6R03												
		12.1											
2TE	B7R		B7R04	B7R05	B7R06	B7R08							
			15.5	16.7	18.5	23.1							
	B1K		B1K04	B1K05	B1K06	B1K08		B1K12			B1K24		
			15.2	17.3	18.6	22.9		30			52.0		
B1T	B1T03												
		16.0											
B3R							B3R10	B3R12	B3R16	B3R20			
							27.1	32.5	40.8	46.5			
3TE		B1T03	B3R04	B3R05	B3R06	B3R08	B3R10	B3R12	B3R16	B3R20	B1T24		
		15.8	15.6	19.5	21.5	24.4	28.4	32.9	41.2	46.5	53.5		
R3 <small>TEXTILES HOSES</small>	B3R					B3R08	B3R10	B3R12	B3R16				
						25.0	28.5	35.8	41.2				
R4 <small>TEXTILES HOSES LISCIO (SMOOTH)</small>								B3R12	B3R16	B3R20	B12T24N	B12T32N	
								34.0	42.4	48.8	58.7	71.7	
R4 <small>SAUGFLEX X- PLUS-G LISCIO (SMOOTH)</small>								B3R12	B3R16	B3R20	B1T24	B12T32N	
								33.5	41.9	47.8	54.7	73.7	
R4 <small>SAUGFLEX CORRUGATO (CORRUCATED)</small>								B3R12	B3R16	B3R20	B1T24	B12T32N	
								30.8	41.7	47.8	55.0	70.2	
CLEAN FARM	B1SC					B1SC08							
						24.4							
B1K						B1K08							
						23.2							
R8* <small>TEXTILES HOSES</small>		B7R03	B1K04	B1K05	B1K06	B1K08							
		11.8	14.0	16.7	17.7	22.4							
R18 <small>TEXTILES HOSES</small>	B1SC		B1SC04	B1SC05	B1SC06								
			15.3	18	20.0								

# CLEANER HOSES

Tubi idropulitrice

NOMINAL BORE	DN	5	6	8	10	12	16	19	25	31	38	51
INTERNAL DIAMETER	inches	3/16"	1/4"	5/16"	3/8"	1/2"	5/8"	3/4"	1"	1.1/4"	1.1/2"	2"
	mm	4.8	6.4	7.9	9.5	12.8	16	19	25.4	31.8	38.1	50.8

<b>TEKNOJET/1SN</b> IEC-60335-2  (scelta consigliata) (recommended option)		<b>B12T..N</b> FOR STANDARD FITTINGS		.04	.05	.06	.08						
			18.0	18.6	20.5	23.4							
			n.s.	n.s.	n.s.	n.s.							
		<b>B1R</b> FOR STANDARD FITTINGS		.04	.05	.06	.08						
				17.2	18.8	21.0	25.4						
				21	22	23	25						
		<b>B1SC</b> FOR STANDARD FITTINGS		.04	.05	.06	.08						
				16.0	17.8	20.0	23.6						
				n.s.	n.s.	n.s.	n.s.						
<b>TEKNOJET/2SN</b> IEC-60335-2  (scelta consigliata) (recommended option)		<b>B2R</b> FOR STANDARD FITTINGS		.04	.05	.06	.08						
				17.8	20.3	23.0	25.7						
				21	22	23	25						
		<b>B12T..N</b> FOR STANDARD FITTINGS		.04	.05	.06	.08						
				19.0	19.6	21.3	24.4						
				n.s.	n.s.	n.s.	n.s.						
<b>TEKNOJET/1SC</b> IEC-60335-2		<b>B1SC</b> FOR STANDARD FITTINGS		.04	.05	.06	.08						
				15.3	16.8	18.6	22.5						
				n.s.	n.s.	n.s.	n.s.						
<b>TEKNOJET/2SC</b> IEC-60335-2  (scelta consigliata) (recommended option)		<b>B12T..N</b> FOR STANDARD FITTINGS		.04	.05	.06	.08						
				18.2	19.0	20.9	23.5						
				n.s.	n.s.	n.s.	n.s.						
		<b>B1SC</b> FOR STANDARD FITTINGS		.04	.05	.06	.08						
				16.2	18.0	20.0	23.8						
				n.s.	n.s.	n.s.	n.s.						
<b>TEKNOJET/1ST</b> IEC-60335-2		<b>B1R</b> FOR STANDARD FITTINGS		.04	.05	.06	.08						
				17.2	18.8	21.0	25.4						
				21	22	23	25						
<b>TEKNOJET/2ST</b> IEC-60335-2		<b>B2R</b> FOR STANDARD FITTINGS		.04	.05	.06	.08						
				17.8	20.3	23.0	25.7						
				21	22	23	25						
<b>TEKNOJET/PLUS 1SN</b>		<b>B1R</b> FOR STANDARD FITTINGS		.04	.05	.06	.08						
				17.2	18.8	21.0	25.4						
				21	22	23	25						
<b>TEKNOJET/PLUS 2SN</b>		<b>B2R</b> FOR STANDARD FITTINGS		.04	.05	.06	.08						
				17.8	20.3	23.0	25.7						
				21	22	23	25						
<b>SEWER CLEANING</b>		<b>B1SC</b> FOR STANDARD FITTINGS					.08	.12	.16				
							22.5	29.1	36.9				
							n.s.	n.s.	*3				
		<b>B1R</b> FOR STANDARD FITTINGS					.08	.12	.16				
							24.3	31.3	*				
					25	34	37						

\*\* Please check compatibility with hose external diameter, that may change depending on the manufacturer's

\*\* Verificare la compatibilità con il diametro esterno del tubo che potrebbe variare a seconda della casa costruttrice.

# ASSEMBLY INSTRUCTIONS

## Istruzioni di assemblaggio

**1- Scegliere il tubo (A), le boccole (B) e gli inserti (C)**

**2- Tagliare il tubo alla lunghezza richiesta, usando una lama rotante di acciaio.**

**3- Se è richiesta la spellatura esterna, asportare più gomma della copertura possibile, fino alla “lunghezza di spellatura” specificata nella presente tabella, evitando di danneggiare i fili di acciaio del rinforzo.**

**4- Posizionare la boccola sul tubo.**

**Inserire l’inserto nel tubo.**

**Selezionare la “SPINA di CONTROLLO COLLASSO”**

**Inserire la SPINA nel foro dell’inserto.**

**La parte “Non Passa” deve entrare completamente nel foro dell’inserto.**

**Rimuovere la SPINA.**

**5- Pressare la boccola al diametro di pressatura specificato nella tabella.**

**6- Controllare il diametro di pressatura misurandolo su ogni coppia di morsetti.**

**Le misure vanno prese al centro della lunghezza della boccola.**

**Tutte le misure prese devono essere in accordo con il diametro di pressatura specificato (+0,01-0,2 mm.).**

**7- Inserire la “SPINA di CONTROLLO COLLASSO”.**

**8- Se la parte “Non passa” della “SPINA di CONTROLLO COLLASSO” si blocca nel foro, il diametro di pressatura ed il collasso del foro sono corretti.**

**9 - Se la parte “Non passa” della “SPINA di CONTROLLO COLLASSO” entra completamente nel foro, il diametro di pressatura deve essere ridotto, di decimo in decimo**

**10 Se la parte “Passa” della “SPINA di CONTROLLO non entra nel foro, il diametro di pressatura deve essere aumentato,**

*1- Select the hose (A), ferrules (B) and inserts (C)*

*2- Cut the hose squarely using a rotary steel blade to the required length.*

*3- If skiving is required, remove all rubber cover to the “skiving length” specified in the table, avoiding damages to the steel wires reinforcement.*

*4- Place the ferrule fully onto the hose.*

*Push the insert fully into the hose.*

*Select the “COLLAPSE CONTROL MANOREL”*

*Insert the MANOREL into the insert bore.*

*The “NO GO” part of the MANOREL must fully go into the insert bore. .*

*Remove the MANOREL.*

*5-Crimp the ferrule to the diameter specified in the table*

*6- Inspect the crimp diameter by measuring it on each die impressions. All measurements must be taken in the center of ferrule length.*

*All measurements must be according to the specified crimping diameters, within a tolerance +0,01-0,2 mm.*

*7- Insert the “COLLAPSE CONTROL MANOREL”.*

*8- If the “NO GO” part of the MANDREL stops in the bore the crimping diameter and the bore collapse are correct.*

*9- If the “NO GO” part of the MANDREL goes through the bore, the crimping diameter must be reduced by increments of 0,1 mm*

*10- If the “GO” part of the MANDREL does not go through the bore, the crimping diameter must be increased.*

## BEFORE PRESSING

Prima della pressatura

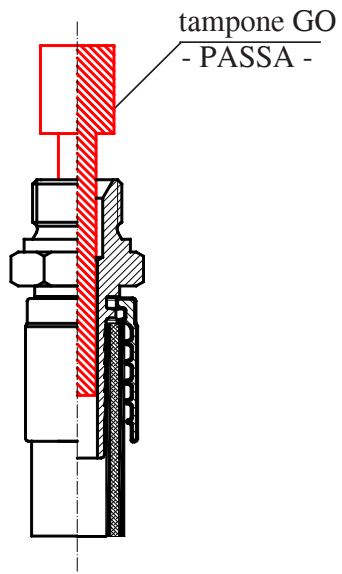

A



B

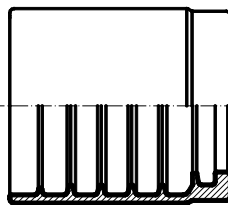

## AFTER PRESSING

Dopo la pressatura

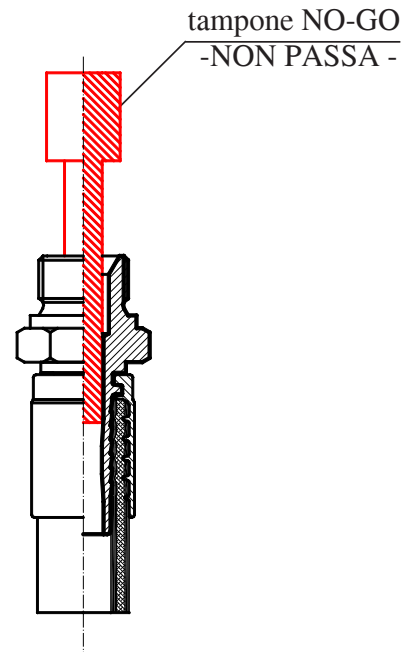

C

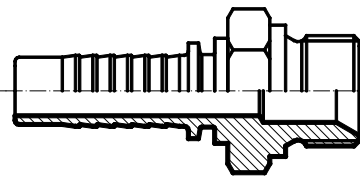

# INSERT BORE COLLAPSE CONTROL

Controllo del collasso foro

## WIRE BRAIDED HOSES STANDARD FITTINGS

NOMINAL SIZE		GO, NO GO MANDRELS DIAMETERS (mm)	
		GO	NO-GO
03	3/16"	2.30	2.80
04	1/4"	3.30	3.75
05	5/16"	4.70	5.20
06	3/8"	6.05	6.55
08	1/2"	8.35	8.75
10	5/8"	10.85	11.40
12	3/4"	13.50	13.80
16	1"	18.50	19.20
20	1.1/4"	23.05	23.90
24	1.1/2"	29.80	30.70
32	2"	41.60	42.60



## WIRE SPIRAL HOSES STANDARD FITTINGS

NOMINAL SIZE		GO, NO GO MANDRELS DIAMETERS (mm)	
		GO	NO-GO
04	1/4"	3.15	3.60
06	3/8"	5.60	6.25
08	1/2"	7.60	8.40
10	5/8"	10.05	10.90
12	3/4"	12.35	13.30
16	1"	17.30	18.35
20	1.1/4"	22.25	23.35
24	1.1/2"	29.15	30.30
32	2"	40.7	42.0

## WIRE SPIRAL HOSES INTERLOCK FITTINGS

NOMINAL SIZE		GO, NO GO MANDRELS DIAMETERS (mm)	
		GO	NO-GO
12	3/4"	12.15	13.10
16	1"	16.50	17.55
20	1.1/4"	22.25	23.35
24	1.1/2"	27.15	28.3
32	2"	38.7	40.0

# HOW TO READ THIS CHART

FERRULE TYPE		DN										
		03	04	05	06	08	10	12	16	20	24	32
TEKNO/1SN	<b>B12T..N</b> FOR STANDARD FITTINGS	16.0	18.0	18.6	20.5	23.4	27.0	30.8	39.1	48.5	57.0	69.4
		n.s.	n.s.	n.s.	n.s.	n.s.	n.s.	n.s.	n.s.	n.s.	n.s.	n.s.
	<b>B1SC</b> FOR STANDARD FITTINGS		04	05	06	08	10	12	16			
		16.0	17.8	20.0	23.6	27.4	30.2	38.9				
		n.s.	n.s.	n.s.	n.s.	n.s.	n.s.	n.s.				
	<b>B1T</b> FOR STANDARD FITTINGS	03	04	05	06	08	10	12	16	20	24	
		15.4	16.4	18.2	20.1	24.2	26.4	30.8	38.9	48.3	54.2	
		n.s.	n.s.	n.s.	n.s.	n.s.	n.s.	n.s.	n.s.	n.s.	n.s.	
	<b>B12T</b> FOR STANDARD FITTINGS					08	10	12				
						23.5	26.4	30.8				
						n.s.	n.s.	n.s.				

n.s. NO SKIVE  
 xx.x OUT SKIVE  
 xx.x/xx.x IN/OUT SKIVE

HOSE TYPE: TEKNO/1SN  
 FITTING TYPE: B12T..N, B1SC, B1T, B12T  
 CRIMPING DIAMETER: 03, 04, 05, 06, 08, 10, 12, 16, 20, 24, 32

