

Lubricant pump P203
for multi-line lubrication systems
DC versions with control PCB V10-V23

Original Assembly Instructions
following machinery directive 2006/42/EC

EN

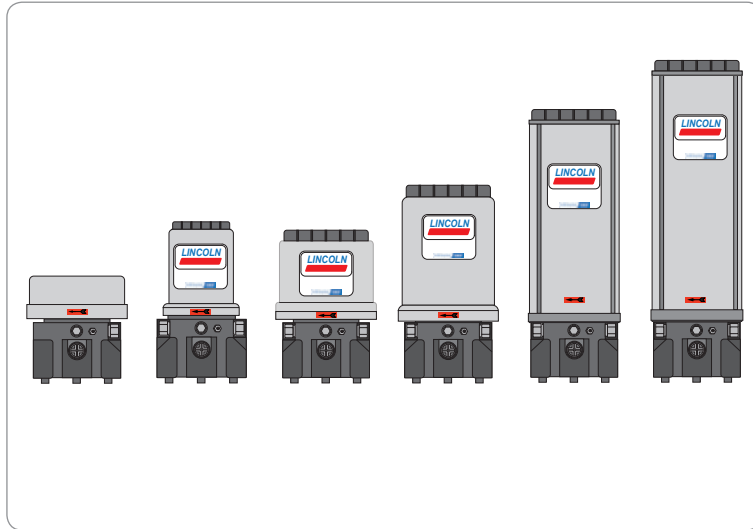

951-171-023-EN

Version 02

21/05/2021



Original EC Declaration of incorporation following machinery directive 2006/42/EG, annex II, part 1 B

SKF Lubrication Systems Germany GmbH, Heinrich-Hertz-Str. 2-8, DE - 69190 Walldorf hereby declares at its sole responsibility that the partly completed machinery complies with the essential health and safety requirements of the Machinery Directive 2006/42/EC, Annex I, marked in the Annex to the EC Declaration of Incorporation as applicable and fulfilled at the time of placing on the market.

The special technical documents were prepared following Annex VII part B. Upon justifiable request, these special technical documents can be forwarded electronically to the respective national authorities. The authorized company for the compilation of the technical documentation is SKF Lubrication Systems Germany GmbH.

Designation: Electrically driven pump to supply lubricant during intermittent operation within a centralized lubrication system
 Types: P203 V DC
 Part number: 6440-xxxxxxx/644-xxxx-x/94xxxxxx, 094xxxxxxx

Furthermore, the following directives and standards were applied in the respective applicable areas:

2011/65/EU	RoHS II	
2014/30/EU	Electromagnetic compatibility	Industry

Standards

EN ISO 12100:2010	EN 60204-1:2018	EN 60034-1:2010/AC:2010	EN 61000-6-4:2007/A1:2011
EN 809:1998+A1:2009/AC:2010	EN 60947-5-1:2004/A1:2009	EN 61000-6-2:2005/AC:2005	
EN IEC 63000:2018	EN 61131-2:2007		

The partly completed machinery must not be put into service until the final machinery into which it is to be incorporated has been declared in conformity with the provisions of machinery directive 2006/42/EC and any other applicable directives.

Walldorf, 21/05/2021

Jürgen Kreutzkämper
 Manager R&D Germany



Stefan Schürmann
 Manager PD
 Germany South



Original UK Declaration of incorporation according to the Supply of Machinery (Safety) Regulations 2008 No. 1597 Annex II

SKF Lubrication Systems Germany GmbH, Heinrich-Hertz-Str. 2-8, DE - 69190 Walldorf hereby declares under sole responsibility that the partly completed machinery complies with the essential health and safety requirements of UK legislation Supply of Machinery (Safety) Regulations 2008 No. 1597 Annex I, marked in the Annex to the EC Declaration of Incorporation as applicable and fulfilled at the time of placing on the market. The special technical documents were prepared following Annex VII part B. Upon justifiable request, these special technical documents can be forwarded electronically to the respective national authorities. The authorized company for the compilation of the technical documentation is SKF (U.K.) Limited, 2 Canada Close, Banbury, Oxfordshire, OX16 2RT, GBR.

Designation: Electrically driven pump to supply lubricant during intermittent operation within a centralized lubrication system
 Types: P203 V DC
 Part number: 6440-xxxxxxx / 644-xxxx-x / 94xxxxxx, 094xxxxxxx

Furthermore, the following regulations and standards were applied in the respective applicable areas:

- The Restriction of the Use of Certain Hazardous Substances in Electrical and Electronic Equipment Regulations 2012 No. 3032
- Electromagnetic Compatibility Regulations 2016 No. 1091

Standards

EN ISO 12100:2010	EN 60204-1:2018	EN 60034-1:2010/AC:2010	EN 61000-6-4:2007/A1:2011
EN 809:1998+A1:2009/AC:2010	EN 60947-5-1:2004/A1:2009	EN 61000-6-2:2005/AC:2005	
EN IEC 63000:2018	EN 61131-2:2007		

The partly completed machinery must not be put into service until it has been established that the machinery into which it is to be incorporated is in compliance with the provisions of UK legislation Supply of Machinery (Safety) Regulations 2008 No. 1597 and all other applicable Directives.

Walldorf, 21/05/2021

Jürgen Kreutzkämper
 Manager R&D Germany



Stefan Schürmann
 Manager PD
 Germany South



Description of the essential health and safety requirements according to 2006/42/EC, Annex I, which have been applied and complied with. Any basic health and safety requirements not listed here are not relevant to this product.

No.:	Basic safety and health requirements	Applicable:	Complied with:
1.1.1	Definitions	YES	YES
1.1.2	Principles of safety integration	YES	YES
1.1.3	Materials and products	YES	YES
As to 1.1.3 Not fully complied with: The operator has to evaluate the hazards caused by the lubricant on the basis of the safety data sheet (SDS) and take protective measures, if necessary.			
1.1.5	Design of machinery to facilitate its handling	YES	YES
1.1.6	Ergonomics	YES	YES
As to 1.1.6 Not fully complied with: The operator has to ensure that the pump is integrated into the superior machine in such a manner that operation and filling of the pump are ergonomically possible.			
1.2	Control systems	YES	YES
1.2.1	Safety and reliability of control systems	YES	YES
1.2.3	Starting	YES	YES
1.2.6	Failure of the power supply	YES	YES
1.3	Protection against mechanical hazards	YES	YES
1.3.1	Risk of loss of stability	YES	YES
1.3.2	Risk of break-up during operation	YES	YES
As to 1.3.2 Not fully complied with: The operator has to secure the lubrication system against excessive pressure. For this purpose a pressure relief valve with max. 350 bar opening pressure must be provided on each pump element.			
1.3.4	Risks due to surfaces, edges or angles	YES	YES
1.3.7	Risks related to moving parts	YES	YES
1.3.9	Risks of uncontrolled movements	YES	YES
1.5	Risks due to other hazards	YES	YES
1.5.1	Electricity supply	YES	YES
1.5.6	Fire	YES	YES
As to 1.5.6 Not fully complied with: For pumps without control unit, the operator has to take suitable measures to ensure that the relative duty cycle (see Technical Data) is complied with. Otherwise the motor may generate unacceptably high heat.			

No.:	Basic safety and health requirements	Applicable:	Complied with:
1.5.8	Noise	YES	YES
1.5.11	External radiation	YES	YES
1.5.13	Emission of hazardous materials and substances	YES	YES
1.5.15	Risk of slipping, tripping and falling	YES	YES
1.6	Maintenance	YES	YES
1.6.1	Machinery maintenance	YES	YES
1.6.2	Access to operating positions and servicing points	YES	YES
As to 1.6.2 Not fully complied with: The operator has to ensure that the pump is integrated into the superior machine in such a manner that operation of the pump is possible without risk.			
1.6.4	Operator interventions	YES	YES
1.7	Information	YES	YES
1.7.1	Information and warnings on the machinery	YES	YES
1.7.1.1	Information and information devices	YES	YES
1.7.2	Warning of residual risks	YES	YES
1.7.3	Marking of machinery	YES	YES
1.7.4	Instructions	YES	YES
1.7.4.1	General principles for the drafting of instructions	YES	YES
1.7.4.2	Contents of the instructions	YES	YES
1.7.4.3	Sales literature	YES	YES

Legal notice

Manufacturer

SKF Lubrication Systems Germany GmbH
e-mail: Lubrication-germany@skf.com
www.skf.com/lubrication

Manufacturer's addresses

Walldorf Facilities

Heinrich-Hertz-Straße 2-8
69190 Walldorf
Germany
Phone: +49 (0) 6227 33-0
Fax: +49 (0) 6227 33-259

Berlin Facilities

Motzener Straße 35/37
12277 Berlin
Germany
Phone +49 (0)30 72002-0
Fax +49 (0)30 72002-111
www.skf.com/lubrication

Training courses

In order to provide a maximum of safety and economic viability, SKF carries out detailed training courses. It is recommended that the training courses are attended. For more information please contact the respective SKF Service address.

Authorized local distributors

Great Britain

SKF (U.K.) Limited,
2 Canada Close, Banbury, Oxfordshire,
OX16 2RT, GBR.

North America

SKF Lubrication Business Unit
Lincoln Industrial
5148 North Hanley Road, St. Louis,
MO. 63134 USA

South America

SKF Argentina Pte. Roca 4145,
CP 2001 Rosario, Santa Fe

EEU Area

LLC SKF
121552, Russia, Moscow,
Yartsevskaya Street, 19, Block A Floor 7

Copyright

© Copyright SKF
All rights reserved.

Warranty

The instructions do not contain any information on the warranty. This can be found in our general terms and conditions.

Disclaimer

The manufacturer shall not be held responsible for damages caused by:

- Non appropriate use
faulty assembly, operation, setting, maintenance, repair or accidents
- Use of inappropriate lubricants
- Improper or late response to malfunctions
- Unauthorized modifications of the product
- Intent or negligence
- Use of non-original SKF spare parts
- Faulty planning or layout of the centralized lubrication system

Liability for loss or damage resulting from the use of our products is limited to the maximum purchase price. Liability for consequential damages of whatever kind is excluded.

Table of contents

























Original EC Declaration of incorporation following machinery directive 2006/42/EG, annex II, part 1 B	2	1.20	Briefing of external technicians.....	17
Original UK Declaration of incorporation according to the Supply of Machinery (Safety) Regulations 2008 No. 1597 Annex II	3	1.21	Provision of personal protective equipment.....	17
Legal notice	6	1.22	Operation.....	17
Explanation of symbols, signs and abbreviations.....	10	1.23	Emergency stopping.....	17
		1.24	Transport, installation, maintenance, malfunctions, repair, shutdown, disposal.....	18
1. Safety instructions.....	12	1.25	Initial commissioning / daily start-up.....	19
1.1 General safety instructions.....	12	1.26	Cleaning	19
1.2 General behaviour when handling the product.....	12	1.27	Residual risks	20
1.3 Intended use.....	13	2. Lubricants.....	21	
1.4 Foreseeable misuse.....	13	2.1 General information	21	
1.5 Modifications of the product.....	13	2.2 Selection of lubricants.....	21	
1.6 Prohibition of certain activities.....	13	2.3 Material compatibility.....	21	
1.7 Painting of plastic parts.....	13	2.4 Temperature characteristics.....	21	
1.8 Notes related to the CE marking	14	2.5 Ageing of lubricants.....	22	
1.9 Inspections prior to delivery	14	2.6 Chisel pastes.....	23	
1.10 Other applicable documents.....	14	2.6.1 Solid lubricants	23	
1.11 ADR test certificate	14	3. Overview, functional description	24	
1.12 Markings on the product.....	15	3.1 Pumps without follower plate.....	24	
1.13 Notes related to the type identification plate.....	16	3.2 Pumps with follower plate	27	
1.14 Notes related to the ECE approval mark	16	4. Technical data	29	
1.15 Notes related to the UL approval mark.....	16	4.1 General technical data.....	29	
1.16 Notes related to the EAC marking.....	16	4.2 Protection types and classes	30	
1.17 Notes related to the UKCA marking.....	16	4.3 Hydraulic connection diagram	30	
1.19 Persons authorized to operate the pump	17			
1.19.1 Operator.....	17			
1.19.2 Specialist in mechanics	17			
1.19.3 Specialist in electrics	17			





4.4	Nominal output volumes	31	6.	Installation	47
4.4.1	Influencing variables on the output volume	31	6.1	General information	47
4.4.2	Output diagrams of typical NLGI 2 lubricants.....	32	6.2	Place of installation.....	47
4.5	Functioning principle of the intermittent low-level indication.....	33	6.3	Mechanical connection.....	48
4.6	Limits of use of the intermittent low-level indication.....	34	6.3.1	Minimum assembly dimensions	48
4.7	Processing of the low-level signals in case of external controller and monitoring of the pump.....	35	6.3.2	Installation bores	51
4.7.1	Visualization of a low-level indication	35	6.4	Electrical connection	53
4.7.2	Remaining run time of pump in case of a low-level indication.....	35	6.5	Adjusting the output volume on the pump element R.....	55
4.8	Reservoir variants.....	36	6.6	Mount pressure control valve	56
4.9	Useable reservoir volume	37	6.7	Lubrication line connection	57
4.10	Lubricant requirement for priming of an empty pump	38	6.8	Filling with lubricant	58
4.11	Tightening torques	39	6.8.1	Filling via the reservoir lid	58
4.12	Factory settings of the lubrication and pause times of pumps with control PCB V10-V23	40	6.8.2	Filling via filler fitting.....	59
4.13	Possible settings of the lubrication and pause times of pumps with control PCB V10-V23	40	6.8.3	Filling via the optional filling connection	60
4.14	Type identification code.....	41	6.8.4	Initial filling of an empty pump with follower plate	61
5.	Delivery, returns, and storage	45	6.9	Setting of lubrication and pause times.....	64
5.1	Delivery	45	6.10	Changing the lubrication and pause times via jumper setting	65
5.2	Returns	45	7.	Initial start-up	66
5.3	Storage.....	45	7.1	Inspections prior to initial start-up.....	66
5.4	Storage temperature range.....	46	7.2	Inspections during initial start-up.....	66
5.5	Storage conditions for parts filled with lubricant	46	7.3	Acknowledge receipt of a fault indication.....	67
5.5.1	Storage period of up to 6 months.....	46	7.4	Triggering an additional lubrication cycle.....	69
5.5.2	Storage period from 6 to 18 months.....	46	8.	Operation	70
5.5.3	Storage period exceeding 18 months	46	8.1	Refill lubricant	70
			9.	Cleaning	71
			9.1	Cleaning agents.....	71
			9.2	Exterior cleaning	71
			9.3	Interior cleaning	71

10.	Maintenance	72	14.13	Reservoir lid.....	85
11.	Troubleshooting	73	14.12	Screw cap.....	85
11.1	Display of the operating states and fault conditions by means of the control PCB's LEDs	74	14.14	Connection sockets and ADR cable	86
12.	Repairs	75	15.	Electrical connections	87
12.1	Replace pump element and pressure control valve	75	15.1	Cable colours following IEC 60757	87
12.2	Replacement of the control PCB	76	15.2	Legend	88
12.3	Installation of the pump at the place of use.....	77	15.3	Connection of signal line to reservoir lid	89
12.4	Tests after replacement of the control PCB.....	78	15.4	Recommended contact protection measure for switching inductive loads	90
13.	Shutdown and disposal	79	15.5	Connection diagram P203 V DC with control PCB V10-V23, 1 of 6 ..	91
13.1	Temporary shutdown	79	15.6	Connection diagram P203 V DC with control PCB V10-V23, 2 of 6 ..	92
13.2	Final shutdown and disassembly	79	15.7	Connection diagram P203 V DC with control PCB V10-V23, 3 of 6 ..	93
13.3	Disposal.....	79	15.8	Connection diagram P203 V DC with control PCB V10-V23, 4 of 6 ..	94
14.	Spare parts	80	15.9	Connection diagram P203 V DC with control PCB V10-V23, 5 of 6 ..	95
14.1	Housing cover assy.	80	15.10	Connection diagram P203 V DC with control PCB V10-V23, 6 of 6 ..	96
14.2	Pump elements.....	80	15.11	Overview of cables and connection options.....	97
14.3	Pressure control valve and adapter	81	16.	China RoHS Table	98
14.4	Adapter D 6 AX 1/8NPT I C	81			
14.5	Motor 12/ 24 V DC.....	81			
14.6	Magnetic switch normally open (NO).....	82			
14.7	Adapter with lubrication fitting.....	82			
14.8	Closure screw M22 x 1,5.....	82			
14.9	Transparent reservoir.....	83			
14.10	Replacement kit control PCB	84			
14.11	Fixed paddle.....	85			

Explanation of symbols, signs and abbreviations

The following abbreviations may be used within these instructions. Symbols within safety notes mark the kind and source of the hazard.

	General warning		Dangerous electrical voltage		Risk of falling		Hot surfaces
	Unintentional intake		Crushing hazard		Pressure injection		Suspended load
	Electrostatically sensitive components		Potentially explosive atmospheres		Keep unauthorized persons away		Wear personal protective equipment (protective clothes)
	Wear personal protective equipment (goggles)		Wear personal protective equipment (face shield)		Wear personal protective equipment (gloves)		
	Wear personal protective equipment (safety shoes)		Disconnect product from mains		General obligation		
	Protective conductor (protection class I)		Protection y double or reinforced insulation (protection class II)		Protection by extra low voltage (protection class III)		Safe galvanic isolation (protection class III)
	CE marking		Disposal, recycling		Disposal of waste electrical and electronic equipment		

Warning level	Consequence	Probability	Symbol	Meaning
 DANGER	Death, serious injury	imminent	●	Chronological guidelines
 WARNING	Death, serious injury	possible	○	Lists
 CAUTION	Minor injury	possible		Refers to other facts, causes, or consequences
NOTICE	Property damage	possible		

Abbreviations and conversion factors

re.	regarding	°C	degrees Celsius	°F	degrees Fahrenheit
approx.	approximately	K	Kelvin	Oz.	ounce
i.e.	that is	N	Newton	fl. oz.	fluid ounce
poss.	possibly	h	hour	in.	inch
if appl.	if applicable	s	second	psi	pounds per square inch
incl.	including	d	day	sq. in.	square inch
min.	minimum	Nm	Newtonmeter	cu. in.	cubic inch
max.	maximum	ml	millilitre	mph	miles per hour
min.	minute	ml/d	millilitre per day	rpm	revolutions per minute
etc.	et cetera	cc	cubic centimetre	gal.	gallon
e.g.	for example	mm	millimetre	lb.	pound
kW	kilowatt	l	litre	hp	horse power
U	Voltage	dB (A)	sound pressure level	kp	kilopond
R	resistance	>	greater than	fpsec	feet per second
I	current	<	less than	conversion factors	
V	volt	±	plus/minus	Length	1 mm = 0.03937 in.
W	watt	∅	diameter	Area	1 cm ² = 0.155 sq.in
AC	alternating current	kg	kilogram	Volume	1 ml = 0.0352 fl.oz.
DC	direct current	rh	relative humidity		1 l = 2.11416 pints (US)
A	ampere	≈	approximately	Mass	1 kg = 2.205 lbs
Ah	ampere hour	=	equal to		1 g = 0.03527 oz.
Hz	frequency [Hertz]	%	per cent	Density	1 kg/cc = 8.3454 lb./gal.(US)
nc	normally closed contact	‰	per mille		1 kg/cc = 0.03613 lb./cu.in.
no	Normally open contact	≥	greater than	Force	1 N = 0.10197 kp
N/A	not applicable	≤	less than	Pressure	1 bar = 14.5 psi
ft.	feet	mm ²	square millimetre	Temperature	°C = (°F-32) x 5/9
		rpm	revolutions per minute	Output	1 kW = 1.34109 hp
		↑	Increases a value	Acceleration	1 m/s ² = 3.28084 ft./s ²
		↓	Reduces a value	Speed	1 m/s = 3.28084 fpsec.
					1 m/s = 2.23694 mph

1. Safety instructions

1.1 General safety instructions

- The owner must ensure that safety information has been read by any persons entrusted with works on the product or by those persons who supervise or instruct the before-mentioned group of persons. In addition, the owner must also ensure that the relevant personnel are fully familiar with and have understood the contents of the Instructions. It is prohibited to commission or operate the products prior to reading the instructions
- These instructions must be kept for further use
- The described products were manufactured according to the state of the art. Risks may, however, arise from a usage not according to the intended purpose and may result in harm to persons or damage to material assets
- Any malfunctions which may affect safety must be remedied immediately. In addition to these Instructions, general statutory regulations for accident prevention and environmental protection must be observed

1.2 General behaviour when handling the product

- The product may be used only in awareness of the potential dangers, in proper technical condition, and according to the information in these instructions
- Familiarize yourself with the functions and operation of the product. The specified assembly and operating steps and their sequences must be observed
- Any unclear points regarding proper condition or correct assembly/ operation must be clarified. Operation is prohibited until issues have been clarified
- Keep unauthorized persons away
- Wear personal protective equipment always
- Precautionary operational measures and instructions for the respective work must be observed
- Responsibilities for different activities must be clearly defined and observed. Uncertainty seriously endangers safety
- Safety-related protective and safety equipment must not be removed, modified or affected otherwise in its function and is to be checked at regular intervals for completeness and function
- If protective and safety equipment has to be dismantled, it must be reassembled immediately after finishing the work, and then checked for correct function
- Remedy occurring faults in the frame of responsibilities. Immediately inform your superior in the case of faults beyond your competence
- Never use parts of the centralized lubrication system or of the machine as standing or climbing aids

1.3 Intended use

Supply of lubricants within a centralized lubrication system following the specifications, technical data and limits stated in these Instructions:

The product is intended exclusively for integration into a different machine.

Usage is allowed exclusively for professional users in the frame of commercial and economic activities.

1.4 Foreseeable misuse

Any usage differing from the one stated in these Instructions is strictly prohibited, particularly a usage:

- outside the indicated ambient temperature range
- with non-specified means of operation
- without adequate pressure control valve
- in continuous operation
- of C3 versions in areas with aggressive and corrosive materials (e.g. with high salt concentration)
- of plastic parts in areas with high ozone levels or in areas with harmful radiation (e.g. ionising radiation)

- to supply, transport, or store hazardous substances and mixtures in accordance with annex I part 2-5 of the CLP regulation (EG 1272/2008) or HCS 29 CFR 1910.1200 marked with GHS01-GHS06 and GHS08 hazard pictograms
- to feed, forward, or store gases, liquefied gases, dissolved gases, vapours, or fluids whose vapour pressure exceeds normal atmospheric pressure of 1013 mbar [14.69 psi] by more than 0.5 bar [7.25 psi] at the maximum permissible operating temperature.
- in an explosion protection zone

1.5 Modifications of the product

Unauthorized conversions or modifications may result in unforeseeable impacts on safety. Therefore, any unauthorized conversions or modifications are expressly prohibited.

1.6 Prohibition of certain activities

Due to potential sources of faults that may not be visible or due to legal regulations the following activities may be carried out by manufacturer specialists or authorized persons only:

- Repairs or changes to the drive
- Replacement of or changes on the pistons of the pump elements
- Changes on the control printed circuit board exceeding adjustment of the lubrication and pause times or the replacement in case of defects.

1.7 Painting of plastic parts

Painting of any plastic parts or seals of the described products is expressly prohibited. Remove or tape plastic parts completely before painting the superior machine

1.8 Notes related to the CE marking

CE marking is effected following the requirements of the applied directives:

- 2014/30/EU
Electromagnetic compatibility
- 2011/65/EU
(RoHS II) Directive on the restriction of the use of certain hazardous substances in electrical and electronic equipment

Reference on Pressure Equipment Directive 2014/68/EU

Because of its performance data the product does not achieve the limit values defined in Article 4 (1) (a) (ii) and is therefore excluded from the scope of application of Pressure Equipment Directive 2014/68/EU following Article 1 (2) (f).

1.9 Inspections prior to delivery

The following inspections were carried out prior to delivery:

- Safety and functional tests
- Electrical inspections following EN 60204-1

1.10 Other applicable documents

In addition to these instructions, the following documents must be observed by the respective target group:

- Operational instructions and approval rules
- Safety data sheet of the lubricant used

Where appropriate:

- Project planning documents
- Additional information on special versions of the pump. You will find these in the special system documentation
- Any documents of other components required to set up the centralized lubrication system

1.11 ADR test certificate

Provided the use of ADR connecting material as stated in the type identification code and correctly performed electrical installation, the lubricant pumps comply with ADR requirements for use outside potentially explosive zones 0, 1 or 2 in vehicle types EX/II, EX/III, FL and AT.

Test institute:
TÜV-SÜD Auto Service GmbH
Component approval marking:
TÜ.EGG.054-01

1.12 Markings on the product



Warning of personal injury from being drawn in, crushed or sheared while the pump is running due to contact with the stirring paddle when the reservoir lid is open.



Warning of spring tension in case of pumps with follower plate.



Rotational direction of the pump.

ADR

TÜ.EGG.054-01

Pumps with ADR approval



Further to the findings of the workplace risk evaluation the operating company has to attach additional markings (e. g. warnings, signs giving orders, prohibition signs or labelling as specified by GHS), where appropriate.

1.13 Notes related to the type identification plate

The type identification plate states important characteristics such as type designation, order number, and regulatory characteristics. To ensure that the loss of data due to an illegible type identification plate is avoided, the characteristics should be entered in the Instructions.

Model: _____

P. No. _____

S. No. _____

(CW/YY) _____

Calendar week/year of construction

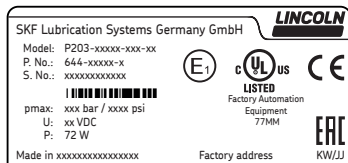
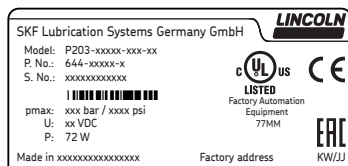

1.14 Notes related to the ECE approval mark



The ECE approval mark (E1) confirms that an ECE design certification (ECE R10) was issued for the product.

1.15 Notes related to the UL approval mark



The UL approval mark confirms that the product has UL certification of compliance with US and Canadian safety regulations.

1.16 Notes related to the EAC marking



The EAC conformity marking confirms the product's conformity with the applicable legal provisions of the Eurasian customs union.

1.17 Notes related to the UKCA marking



The UKCA conformity marking confirms the product's conformity with the applicable legal provisions of Great Britain.

1.18 Notes related to the China RoHS marking



The China RoHS marking confirms that there is no danger to persons or the environment from the regulated substances contained within the intended period of use (number in the circle) of the product.

1.19 Persons authorized to operate the pump

1.19.1 Operator

A person who is qualified by training, knowledge and experience to carry out the functions and activities related to normal operation. This includes avoiding possible hazards that may arise during operation.

1.19.2 Specialist in mechanics

Person with appropriate professional education, knowledge and experience to detect and avoid the hazards that may arise during transport, installation, start-up, operation, maintenance, repair and disassembly.

1.19.3 Specialist in electrics

Person with appropriate professional education, knowledge and experience to detect and avoid the hazards that may arise from electricity.

1.20 Briefing of external technicians

Prior to commencing the activities, external technicians must be informed by the operator of the company safety provisions, the applicable accident prevention regulations to be maintained, and the functions of the superordinate machine and its protective devices.

1.21 Provision of personal protective equipment

The operator must provide suitable personal protective equipment for the respective location of operation and the purpose of operation.

1.22 Operation

The following must be observed during commissioning and operation:

- Any information within this manual and the information within the referenced documents
- All laws and regulations to be complied with by the user

1.23 Emergency stopping

In case of an emergency stop the pump station by:

- Interrupting the power supply to the pump
- Where appropriate, using measures determined by the operator, such as actuating the emergency stop switch of the superior machine

1.24 Transport, installation, maintenance, malfunctions, repair, shutdown, disposal

- All relevant persons must be informed of the activity prior to starting any work. Observe the precautionary operational measures and work instructions
- Carry out transport using suitable transport and hoisting equipment on suitable ways only
- Maintenance and repair work can be subject to restrictions at low or high temperatures (e.g. changed flow properties of the lubricant). Therefore, where possible, try to carry out maintenance and repair work at room temperature.
- Prior to performing work, the product and the machine, into which the product will be integrated, must be depressurized and secured against unauthorized activation
- Ensure through suitable measures that movable or detached parts are immobilized during the work and that no limbs can be caught in between by inadvertent movements
- Assemble the product only outside of the operating range of moving parts, at an adequate distance from sources of heat or cold. Other units of the machine or vehicle must not be damaged or impaired in their function by the installation
- Dry or cover wet, slippery surfaces accordingly
- Cover hot or cold surfaces accordingly
- Work on electrical components must be carried out by electrical specialists only. Observe any waiting periods for discharging, if necessary
- Carry out works on electrical components only while the system is depressurized and use voltage isolated tools suitable for electrical works only
- Carry out electrical connections only according to the information in the valid wiring diagram and taking the relevant regulations and the local connection conditions into account
- Do not touch cables or electrical components with wet or damp hands
- Fuses must not be bypassed Replace defective fuses always by fuses of the same type
- Ensure proper connection of the protective conductor in case of products of protection class I
- Observe the stated type of protection
- Undertake drilling at non-critical, non-load bearing parts only. Use any available boreholes. Do not damage lines and cables when drilling.
- Observe possible abrasion points. Protect the parts accordingly

- All components used must be designed according to the maximum operating pressure and the maximum respectively minimum ambient temperature
- No parts of the centralized lubrication system may be subjected to torsion, shear, or bending
- Check all parts prior to their usage for contamination and clean, if necessary
- Lubricant lines must be primed with lubricant prior to installation. This makes the subsequent ventilation of the system easier
- Observe the specified tightening torques. When tightening, use a calibrated torque wrench,
- When working with heavy parts use suitable lifting tools
- Avoid mixing up or wrong assembly of dismantled parts. Mark these parts accordingly

1.25 Initial commissioning / daily start-up

Ensure that:

- All safety devices are completely available and functional
- All connections are correctly connected
- All parts are correctly installed
- All warning labels on the product are present completely, highly visible and undamaged
- Illegible or missing warning labels are to be replaced without delay

1.26 Cleaning

- Risk of fire and explosion when using inflammable cleaning agents Only use non-flammable cleaning agents suitable for the purpose
- Do not use aggressive cleaning agents
- Thoroughly remove residues of cleaning agents from the product
- Do not use steam jet and high pressure cleaners. Electrical components may be damaged. Observe the type of protection of the pump
- Cleaning work may not be carried out on energized components
- Mark damp areas accordingly

1.27 Residual risks

Residual risk	Possible in life cycle											Prevention/ remedy	
Personal injury/ material damage due to falling of raised parts	A	B	C					G	H	K			Keep unauthorized persons away. No people may remain under suspended loads. Lift parts with adequate lifting devices.
Personal injury/ material damage due to tilting or falling of the product because of non-observance of the stated tightening torques			B	C				G					Observe the specified tightening torques. Fix the product to components with adequate load-bearing capacities only. If no tightening torques are stated, apply tightening torques according to the screw size characteristics for 8.8 screws.
Personal injury/ material damage due to electric shock in case of damage to the connection cable			B	C	D	E	F	G	H				Check the connection cable with regard to damages before the first usage and then at regular intervals. Do not mount cable to moving parts or friction points. If this cannot be avoided, use spring coils respectively protective conduits.
Personal injury/ damage to material due to spilled or leaked lubricant			B	C	D		F	G	H	K			Be careful when filling the reservoir and when connecting or disconnecting lubricant feed lines. Always use suitable hydraulic screw connections and lubrication lines for the stated pressures. Do not mount lubrication lines to moving parts or friction points. If this cannot be avoided, use spring coils respectively protective conduits.
Loss of electrical protective function due to faulty installation of electrical components after repair								G					After replacement of electrical components carry out an electrical safety test according to EN 60204-1.
Reservoir with follower plate is subjected to spring load								G					Remove reservoir with follower plate only when the spring is quite released (i.e. the reservoir is empty). Provide adequate protective measure, e.g. fastening straps, when loosening the reservoir. Do not work with your head directly above the reservoir.
Warning of personal injury from being drawn in, crushed or sheared while the pump is running due to contact with the stirring paddles when the reservoir lid is open.			B	C	D	E	F	G					Never reach into the reservoir while the pump is running. Remove reservoir lid only, if pump has been disconnected electrically from the mains beforehand.
Life phases: A = transport, B = installation, C = initial start-up, D = operation, E = cleaning, F = maintenance, G = fault, repair, H = shutdown, K = disposal													

2. Lubricants

2.1 General information

Lubricants are used specifically for certain application purposes. In order to fulfil their tasks, lubricants must fulfil various requirements.

The most important requirements for lubricants are:

- Reduction of abrasion and wear
- Corrosion protection
- Noise minimisation
- protection against contamination or penetration of foreign objects
- Cooling (primarily with oils)
- longevity (physical/ chemical stability)
- economic and ecological aspects

2.2 Selection of lubricants

SKF considers lubricants to be an element of system design. A suitable lubricant is selected already when designing the machine and forms the basis for the planning of a centralized lubrication system.

The selection is made by the manufacturer or operator of the machine, preferably together with the lubricant supplier based on the requirement profile defined.

Should you have little or no experience with the selection of lubricants for centralized lubrication systems, please contact SKF.

If required we will be glad to support customers to select suitable components for feeding the selected lubricant and to plan and design their centralized lubrication system.

You will avoid possible downtimes through damage to your machine or system or damage to the centralized lubrication system.

2.3 Material compatibility

Lubricants must generally be compatible with the following materials:

- steel, grey iron, brass, copper, aluminium
- ABS, CR, FPM, NBR, NR, PA, PET, PMMA, POM, PP, PS, PTFE, PU, PUR

2.4 Temperature characteristics

The lubricant used must be suitable for the specific ambient temperature of the product. The viscosity required for proper operation of the product must be adhered to and must not be exceeded in case of low temperatures nor fall below specification in case of high temperatures. Specified viscosities, see chapter Technical data.

2.5 Ageing of lubricants

After a prolonged downtime of the machine, the lubricant must be inspected prior to re-commissioning as to whether it is still suitable for use due to chemical or physical ageing. We recommend that you undertake this inspection already after a machine downtime of 1 week.

If doubts arise as to a further suitability of the lubricant, please replace it prior to re-commissioning and, if necessary, undertake initial lubrication by hand.

It is possible for lubricants to be tested in the company's laboratory for their suitability for being pumped in centralized lubrication systems (e.g. "bleeding").

Please contact SKF. If you have further questions regarding lubricants.

You may request an overview of the lubricants tested by SKF.



Only lubricants specified for the product (see chapter Technical data) may be used. Unsuitable lubricants may lead to a failure of the product.



Do not mix lubricants. This may have unforeseeable effects on the usability and therefore on the function of the centralized lubrication system.



When handling lubricants the relevant safety data sheets and hazard designations, if any, on the packaging have to be observed.



Due to the multitude of possible additives, individual lubricants, which according to the manufacturer's data sheets fulfil the necessary specification, may not, in fact, be suitable for use in centralized lubrication systems (e. g. incompatibility between synthetic lubricants and materials). In order to avoid this, always use lubricants tested by SKF.

2.6 Chisel pastes

NOTICE

Damage to the superior machine

Chisel pastes must not be used as a lubricant for bearings.

NOTICE

Damage of the centralized lubrication system

Chisel pastes may be supplied by pump element C only. Hereby the maximum operating pressure must not exceed 200 bar [2900 psi], as otherwise the solid lubricants contained in the chisel paste may cause increased wear.

2.6.1 Solid lubricants



Solid lubricants may be used only upon prior consultation of SKF Lubrications Systems.

With regard to the different solid lubricants contained in chisel pastes, please observe the following:

Graphite

max. graphite content 8 %
max. particle size 25 µm
(possibly in in lamellar structure)

MoS₂

max. MoS₂ content 5 %
max. particle size 15 µm

Copper

Chisel pastes containing copper are likely to result in a layer formation on pistons, bores and mating surfaces. This may cause blockages in the centralized lubrication system.

Calcium carbonate

Chisel pastes containing calcium carbonate are likely to cause a very strong wear on pistons, bores and mating surfaces.

Calcium hydroxide

Chisel pastes containing calcium hydroxide are likely to harden strongly, what may result in a downtime of the centralized lubrication system.

PTFE, zinc and aluminium

Due to the findings and practical experiences gained so far, no limit values can be set for these solid lubricants yet.

3. Overview, functional description

3.1 Pumps without follower plate

1 Reservoir

The lubricant is stored in the reservoir. Depending on the pump version there are different types of reservoirs and reservoir sizes.

1.1 Reservoir lid

Serves to fill the reservoir with suitable clean lubricant and as a protection against contamination of the lubricant.

1.2 Reservoir venting device

It provides air for the reservoir while the pump is operating and lubricant is supplied.

10 Stirring paddle

While the pump operates, the stirring paddle homogenises and smoothes the lubricant. The stirring paddle's lower vertical part pushes the lubricant towards the pump elements thus improving the suction behaviour of the pump.

Overview, functional description of pumps without follower plate Fig. 1

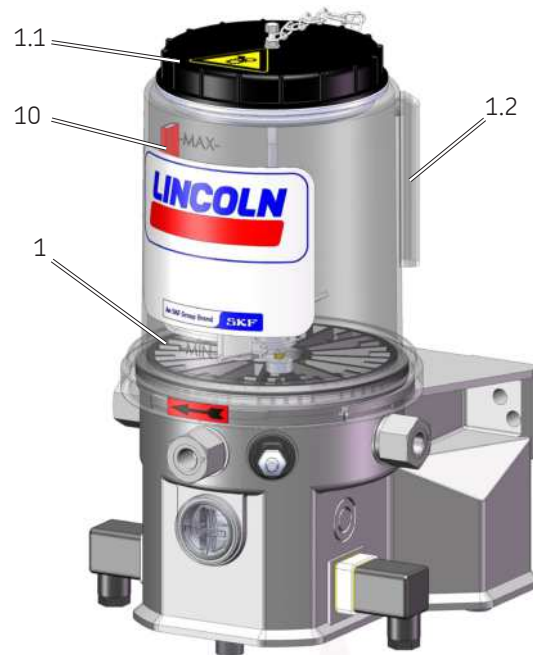

2 Pump housing

The pump housing accommodates the motor, the electrical connections, the filler fitting, the pump elements, the control PCB and, if need be, the intermittent low-level indication.

3 Pump elements

The pump can be equipped with up to 3 pump elements.

4 Filler fitting

Serves to fill the pump from the bottom. If the filler fitting is removed, this port can be used to connect the external grease return from the pressure control valves to the pump elements with corresponding accessories.

5 Electrical connections

They are used for (5.1) power supply (input) and for (5.2) signal connection (output) of the pump. According to the specific pump version the electrical connections come as square plugs, bayonet plugs or as screwed cable gland with Deutsch plug.

Overview, functional description of pumps without follower plate Fig. 2

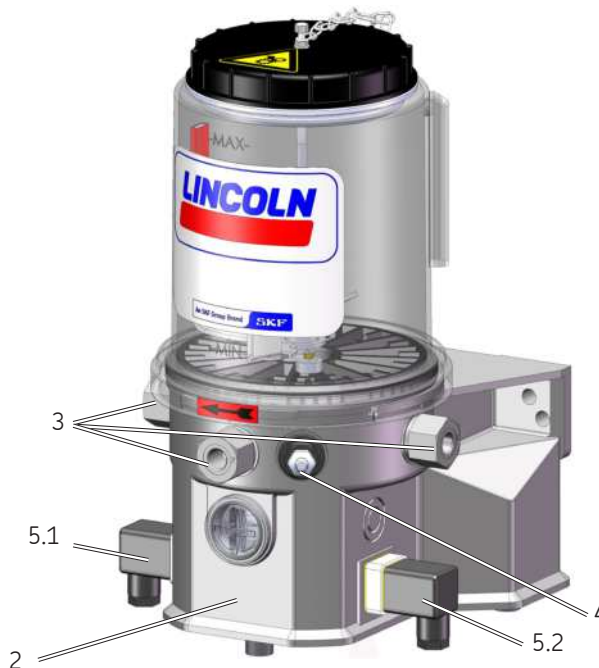

Types of connections

Square plug
DIN EN 175301-803



Bayonet plug
ISO 15170-1

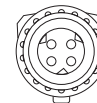
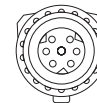

9 Screw cap of control PCB

The screw cap (9) allows to see the operating or error states (LED displays on the control PCB).

Remove the screw cap (9) by turning it anti-clockwise to trigger an additional lubrication or to adjust lubrication and pause times on the control PCB. Then tighten the screw cap again by applying the stated tightening torque.

11 Control PCB

The control PCB is seated behind the screw cap. After removing the screw cap it is possible to adjust the lubrication time (jumper) and the pause time (blue rotary switch) or to trigger an additional lubrication (pushbutton). The control PCB is equipped with an EEPROM. Thus the PCB's data are protected against loss.

Overview, functional description of the control PCB Fig. 3

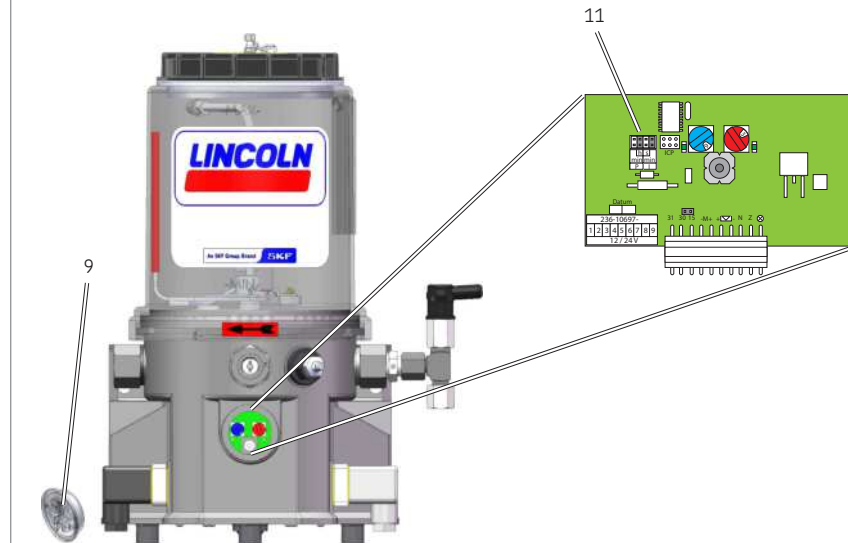

3.2 Pumps with follower plate

1 Reservoir

The lubricant is stored in the reservoir. Depending on the pump version there are different types of reservoirs and reservoir sizes.

1.2 Reservoir venting device

It provides air for the reservoir while the pump is operating and lubricant is supplied. It vents the reservoir while the pump is filled.

6 Follower plate

The follower plate (6) rests on the lubricant and presses it down in the direction of the pump elements by spring force. As a result the suction behaviour of the pump improves.

7 Contact rod

The contact rod (7) of the follower plate accommodates the reed contacts for the low-level function. In the follower plate there is a magnet that actuates the reed contact when reaching a certain switch point. The reed contact for the low-level indication is positioned at the lower switch point.

Overview, functional description of pumps with follower plate Fig. 4

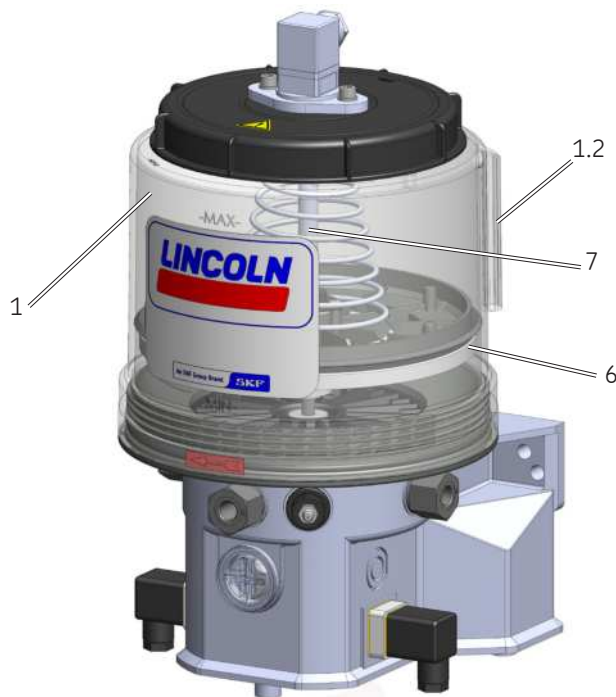

2 Pump housing

The pump housing accommodates the motor, the electrical connections, the filler fitting, the pump elements and the control PCB.

3 Pump elements

The pump can be equipped with up to 3 pump elements.

4 Filler fitting

Serves to fill the pump. If the filler fitting is removed, this port can be used to connect the external grease return from the pressure control valves to the pump elements with corresponding accessories.

5 Electrical connections

Serve to provide (5.1) the power supply (input), to connect the filling level indications (5.3) in case of pumps with follower plate, and to provide (5.2) the signal connection (output) of the pump. According to the specific pump version the electrical connections come as square plugs, bayonet plugs or as screwed cable gland with cable and Deutsch plug.

Overview, functional description of pumps with follower plate Fig. 5

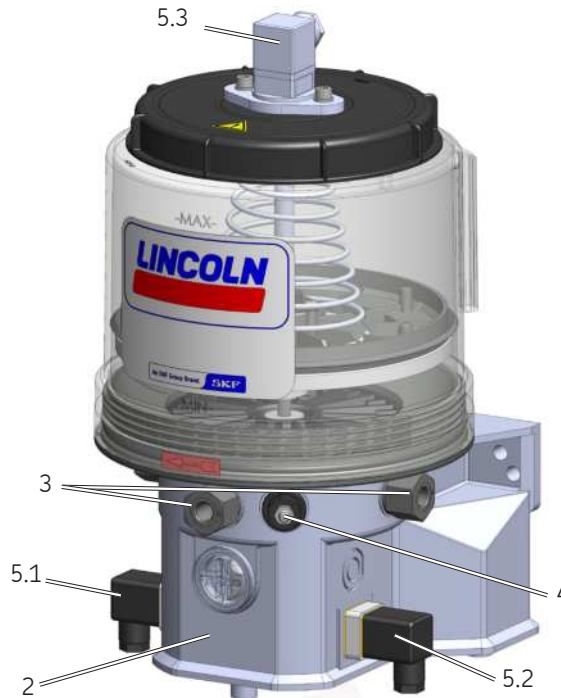

Types of connections

Square plug
DIN EN 175301-803



Bayonet plug
ISO 15170-1

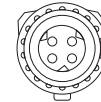
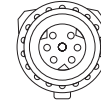

4. Technical data

4.1 General technical data

Operating pressure	max. 350 bar [5076 psi]	12 V DC pump	24 V DC pump
Number of pump elements	max. 3	Rated voltage	12 V DC \pm 10 %
Direction of rotation	clockwise	Recommended back-up fuse	6 A (T)
Sound pressure level	< 70 dB (A)	Current consumption	6 A
Nominal speed	20 rpm	Output (signal)	floating
Relative duty cycle ¹⁾	S3 25 ED 120 min	Max. switching capacity	72 VA
Ambient temperature ¹⁾	-40 °C to +70 °C [-40 °F to +158 °F]	Max. switching voltage	30 V DC
Installation position ²⁾	vertical, i.e. reservoir at top.	Max. switching current	700 mA
Protection type and class	see next page		
Lubricants ³⁾	- Lubrication greases up to and including NLGI 2	Weight of the empty pump	
	- Lubrication oils of at least 40 mm ² /s (cST) at ambient temperature	02 litres, approx. 6.5 kg	[0.53 gal. approx. 14.3 lbs.]
	- Chisel paste (see chapter Lubricants)	04 litres, approx. 9.0 kg	[1.06 gal. approx. 19.8 lbs.]
Filling	Depending on the specific pump type via:	08 litres, approx. 10 kg	[2.11 gal. approx. 22.0 lbs.]
	- Filler fitting	11 litres, approx. 12 kg	[2.90 gal. approx. 26.5 lbs.]
	- Reservoir lid (for reservoirs without follower plate)	15 litres, approx. 14 kg	[3.96 gal. approx. 30.9 lbs.]
	- Optional filling connection		

1) The lower limit of the ambient temperature presupposes the pumpability of the lubricant used at the respective actually existing temperature. The maximum admissible ambient temperature depends on the load and is mainly determined by the runtime and the operating pressure. The stated relative duty cycle refers to lubricants of NLGI 2, an ambient temperature of 60 °C [140 °F] and a medium back pressure of 160 bar on the pump element. In case of temperatures \geq 60 °C and heavy load (higher pressure) the maximum duty cycle should be reduced. 3) Pumps with UL approval may only be operated up to a maximum permissible ambient temperature of +60 °C, regardless of the load.

2) Pumps with follower plate allow for a rotating installation as well, e. g. in wind turbine generators. Maximum speed and maximum distance to the rotation axis on request. For pumps without follower plate and expected inclined position (e.g. In case of construction or agricultural machinery) the following applies:

- The maximum filling must be reduced according to the expected inclined position (< MAX marking).

- The minimum filling must be increased as of an expected inclination of > 30 ° (> MIN marking), as otherwise a reduced lubricant volume in the suction area of the pump could result in a functional impairment.

3) Observe the limits stated in chapter Limits of use of the intermittent low-level indication.

4.2 Protection types and classes

Degree of protection	IP6K9K
Types of protection	
- Square plug	SELV / PELV / FELV
- Bayonet plug	SELV / PELV
- Screwed cable gland with cable and Deutsch plug	SELV / PELV



The specified degree of protection of the pump assumes that IP6K9K-capable connection sockets and corresponding cables are used. When using connection sockets and cables with a lower degree of protection, classification is made according to the lowest degree of protection. For the achievable degrees of protection when using the connection sockets and cables supplied by us, see chapter Spare parts.

4.3 Hydraulic connection diagram

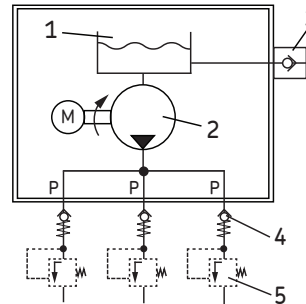

- 1 = Reservoir
- 2 = Pump
- 3 = Filler fitting
- 4 = Check valve
- 5 = Pressure control valve
- P = Pressure line

4.4 Nominal output volumes



In case of pump elements 5, 6, 7 and R, the stated nominal outputs per stroke refer to NLGI 2 lubrication greases, for pump element L they refer to NLGI 0 lubrication greases, at an ambient temperature of + 20 °C [68 °F] and a back pressure of 100 bar [1450 psi] on the pump element. Deviating operating conditions or deviating pump configuration result in a changed motor speed and thus in a change of the output per time unit. If as a consequence of the changed motor speed the output per time unit needs to be adapted, this will be done by adapting the lubrication and pause time settings of the pump.

Pump element	L ⁴⁾	5	6	7	R	B	C ⁵⁾	Unit
Nominal output per stroke	0.03	0.10	0.16	0.22	0.04 / 0.18	0.10	0.24	cc

4.4.1 Influencing variables on the output volume

Influencing variables	Increasing the output	Reducing the output
Ambient temperature	> + 20 °C	< + 20 °C
Consistency class of the lubrication grease	< NLGI 2	N/A
Number of pump elements	N/A	> 1
Back pressure at the pump element	< 100 bar	> 100 bar

⁴⁾ Pump element L must not be used for pumps with follower plate. With the pump element L, lubricants according to the specifications mentioned in these instructions up to class < NLGI 2 can be pumped without restrictions. For lubricants of class NLGI 2, the suitability of pump element L for pumping from temperatures of -5 °C or lower must be checked in each individual case.

⁵⁾ Pump element C serves to supply exclusively chisel paste. When using chisel paste, observe the corresponding notes in the chapter Lubricants.

4.4.2 Output diagrams of typical NLGI 2 lubricants

Low temperature lubrication grease

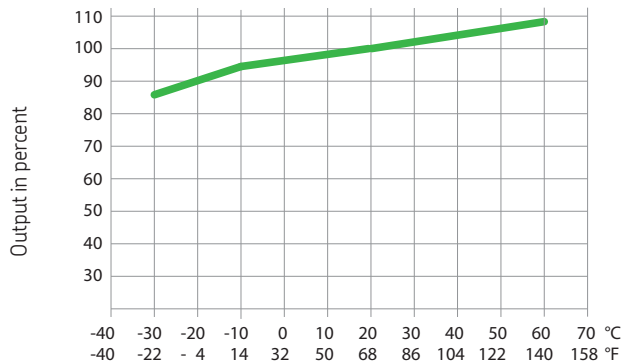

High temperature lubrication grease

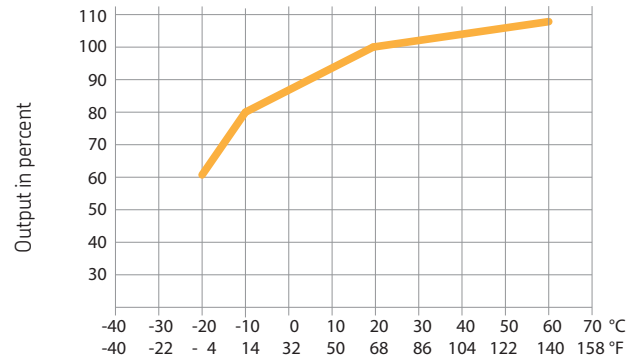

The output diagrams represent the average value of the different high- respectively low-temperature lubrication greases.

Calculation of the output using the example of a high-temperature lubrication grease

Nominal speed of the pump motor per minute x nominal output of pump element 7 per stroke x efficiency in percent at an assumed ambient temperature of -10 °C [14 °F] = 20 rpm x 0.22 cc (0.0134) x 80 % = 3.5 cc/min [0.214 cu.in./min.].

4.5 Functioning principle of the intermittent low-level indication

The intermittent low-level indication operates free of contact. Its main components are the following:

- o firmly positioned magnetic switch (I) inside of the reservoir bottom
- o flexible guide plate (II) connected to the stirring paddle with a magnet (III) and a control cam (IV)

If the reservoir is filled with a lubrication grease suitable for the intermittent low-level indication and the pump is operating, then the guide plate (II) is deflected by the resistance of the lubrication grease. As a consequence the magnet (III) connected to the guide plate (II) is moved on its inner circuit and cannot trigger a pulse at the magnetic switch (I) with its magnetic field. A control cam (IV) positively guides the magnet together with the pivoted guide plate towards the outside during each revolution. As soon as the guide plate leaves the control cam, the lubricant's resistance pushes the guide plate together with the magnet to the inside again.

As soon as the lubricant inside the reservoir has fallen to that level that the lubricant's resistance is no more sufficient to further deflect the guide plate (II), the magnet (III) remains on the outer circuit and triggers a pulse each time it slides across the magnetic switch (I). If during an operating cycle the magnet (III) slides across the magnetic switch (I) six times, a low-level signal is sent by the control printed circuit board of the pump. For programming of the external control of the pump, see corresponding chapter in these instructions.

Perspective representation

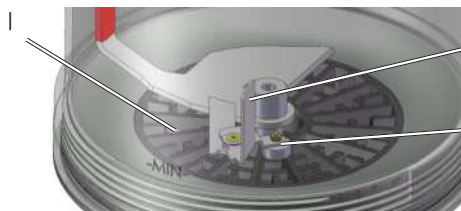

Schematic representation

Magnet on inner circuit

Magnet on outer circuit

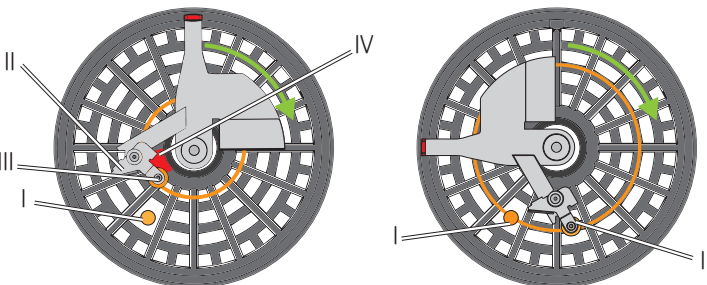

4.6 Limits of use of the intermittent low-level indication

The following lubricant consistencies have to be complied with in order to ensure the correct functioning of the intermittent low-level indication. Above the stated range of temperature a correct functioning of the intermittent low-level indication cannot be ensured. The inferior temperature ranges require the suitability of the lubricant for the respective temperature range. Otherwise the too high consistency of the lubricant may result in malfunctions, e.g. interruption of the lubricant supply, or in damages to the pump (e. g. bending of the stirring paddle).



The intermittent low-level indication is not appropriate for lubrication grease of NLGI class ≤ 0 .

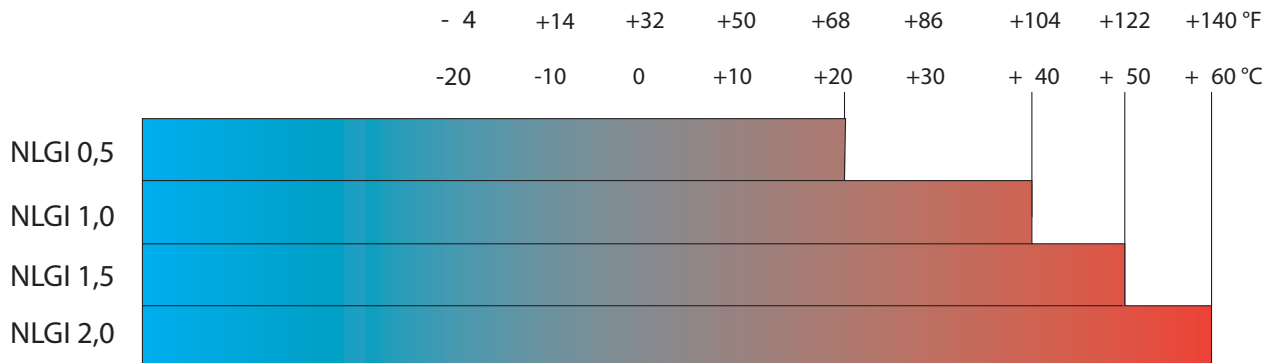

4.7 Processing of the low-level signals in case of external controller and monitoring of the pump

The following statements apply to pumps with control printed circuit board type V and for pumps without printed circuit board with external controller and monitoring.

To avoid early low-level indication (e.g. caused by air inclusions or wave formation in the lubricant) in case of external controller or monitoring the following conditions have to be fulfilled by programming the external controller accordingly.

- After each operating cycle the pulses of the intermittent low-level indications have to be deleted.



Pulses must never be added up over several operating cycles. This may result in an early low-level indication.

Operating cycle ≥ 32 seconds:

- Each operating cycle requires at least 6 signals by the magnetic switch .

Operating cycle ≥ 24 seconds ≤ 32 seconds:

- Each operating cycle requires at least 4 signals by the magnetic switch.

Operating cycle ≤ 24 seconds:

- The number of required magnetic switch signals has to be adapted to the operating conditions to be expected.
To do so, contact our Customer Service.

4.7.1 Visualization of a low-level indication

The low-level indication is evaluated externally as shown in the connection diagram.





4.7.2 Remaining run time of pump in case of a low-level indication

The owner has to ensure that the pump is stopped by the external control unit latest 4 minutes after a low-level-indication has been detected (4 pulses).

4.8 Reservoir variants

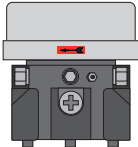
In the following you find the possible reservoir variants of the pumps described in these instructions (also see type identification code). For a better representation only the smallest possible reservoir size will be depicted always. In the figures the different reservoir variants may not always be distinguishable visually, as the differences are located in the interior construction (e.g. with and without low level indication).

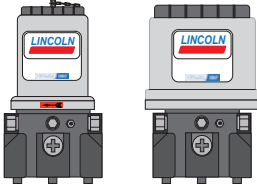
(✓ = available reservoir sizes)

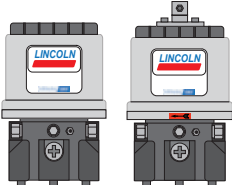
XNFL						XN / XL / XC ¹⁹⁾					XNBO / XLBO / XCBO					XNBA / XLBA / YLBA ²⁰⁾															
litre	2*	4	8	11	15	2	4*	8*	11*	15*	2	4*	8*	11*	15*	2	4*	8*	11*	15*											
gal.	00:53	01:06	02:11	2.9	3.96	00:53	01:06	02:11	2.9	3.96	00:53	01:06	02:11	2.9	3.96	00:53	01:06	02:11	2.9	3.96											
	✓					✓	✓	✓		✓	✓	✓	✓	✓	✓		✓	✓													
																															
XBF / XPF ²¹⁾						YNBO / YLBO																									
litre	2	4*	8*	11*	15*	2	4*	8*	11*	15*																					
gal.	00:53	01:06	02:11	2.9	3.96	00:53	01:06	02:11	2.9	3.96																					
		✓	✓	✓	✓	✓	✓	✓		✓																					
																															

* These reservoir sizes require an adapter 226-14105-5, if a pressure control valve shall be mounted into the pump element.

¹⁹⁾ Reservoir XC is not available as 15-l version.

²⁰⁾ Reservoir YLBA is available as 8-l version only.

²¹⁾ Reservoir XPF is available as 8- and 15-l version only.

4.9 Useable reservoir volume



Regarding the reservoir version without follower plate the useable reservoir volume mainly depends on the NLGI consistency class of the lubricant used and of the ambient temperature. In case of high consistency and low operating temperature normally more lubricant sticks to the inner surfaces of the reservoir and the pump and is thus no more available for being dispensed.

Useable reservoir volume (reservoir without follower plate)	Litres [gal.]	2 [0.53]	4 [1.06]	8 [2.11]	11 [2.90]	15 [3.96]
Lubricants with relatively low consistency ^{6), 8)}	Litres [gal.]	1.6 / 2.0 [0.42 - 0.53]	3.65 / 4.15 [0.96 - 1.10]	6.65 / 7.15 [1.76 - 1.88]	8.78 / 9.28 [2.32 - 2.45]	14.35 / 14.90 [3.79 - 3.93]
Lubricants with relatively high consistency ⁷⁾	Litres [gal.]	1.8 / 2.0 [0.47 - 0.53]	3.35 / 3.85 [0.88 - 1.01]	7.00 / 7.50 [1.84 - 1.98]	9.13 / 9.63 [2.41 - 2.54]	14.75 / 15.25 [3.90 - 4.03]

⁶⁾ Lubricant consistencies of NLGI 000 lubricants at + 60 °C [140 °F] up to lubricant consistencies of NLGI 1.5 lubricants at + 20 °C [68 °F].

⁷⁾ Lubricant consistencies of NLGI 2 lubricants at + 20 °C [68 °F] up to the maximum admissible lubricant consistency.

⁸⁾ When using lubricants of a relatively low consistency in pumps subjected to strong vibrations or tilting motions (e.g. construction and agricultural machinery), make sure to maintain a level that is about 15 mm [0.59 in.] below the MAX marking of the reservoir. This prevents lubricant from entering the reservoir vent. In case of very strong vibrations or large tilting motions this value must be increased, for low vibrations it can be reduced. Changing the filling level by 10 mm [0.4 in.] corresponds to a volume change of about 0.34 litres [0.09 gal.].

4.10 Lubricant requirement for priming of an empty pump

To prime an empty pump up to the MAX marking of the reservoir, the following lubricant quantities are required.

Nominal volume Litres / [gal.]		2 [0.53]	4 [1.06]	8 [2.11]	11 [2.90]	15 [3.96]
required lubricant quantity	litre	3.8 ± 0.25	5.8 ± 0.25	9.15 ± 0.25	12.1 ± 0.25	17.5 ± 0.25
	[gal.]	$[1 \pm 0.07]$	$[1.53 \pm 0.07]$	$[2.41 \pm 0.07]$	$[3.20 \pm 0.07]$	$[4.62 \pm 0.07]$



The deviation between the lubricant quantity required for priming and the nominal volume of the reservoir results from the filling of the pump housing up to the MIN marking of the reservoir.

4.11 Tightening torques

A	Pump element	20 Nm ± 2,0 Nm	[14.75 ft. lb. ± 1.4 ft.lb.]
B	Pressure control valve	6 Nm -0,5 Nm	[4.43 ft. lb. - 0.07 ft.lb.]
C	Pump	18 Nm ± 1.0	[13.27 ft.lb. ± 0.74 ft.lb.]
D	Screw lid	2 Nm ± 0.2	[1.48 ft. lb. ± 0.15 ft.lb.]
E	Housing cover (bottom side)	0.75 Nm ± 0.1 Nm	[0.55 ft. lb. ± 0.07 ft.lb.]
F	optional filling connection	20 Nm + 2.0 Nm	[14.75 ft. lb. ± 1.4 ft.lb.]
G	Closure screw Adapter to hydraulic lubrication fitting	10 Nm + 1.0 Nm	[7.38 ft. lb. ± 0.7 ft.lb.]
H	Square plug screw M3	0.5 Nm	[0,37 ft.lb.]

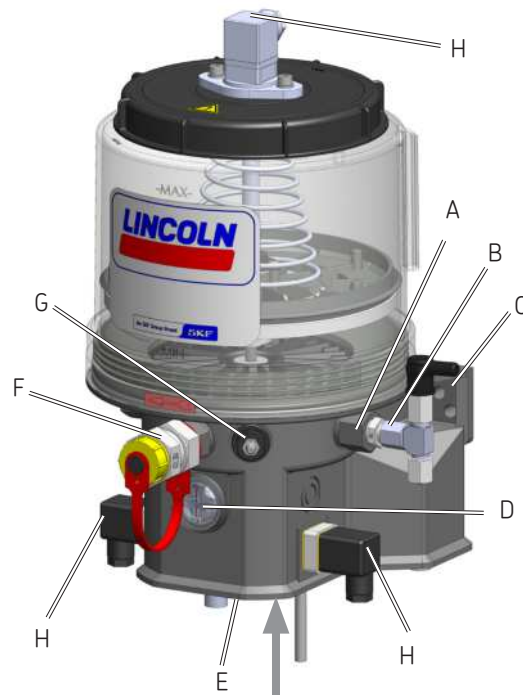

4.12 Factory settings of the lubrication and pause times of pumps with control PCB V10-V23

Printed circuit board	Pause time/ lubrication time	Time value	Rotary switch	Position	Printed circuit board	Pause time/ lubrication time	Time value	Rotary switch	Position
V10/V20	Pause time	6 hrs	blue	6	V12/V22	Pause time	24 min	blue	6
	Lubrication time	6 min	red	3		Lubrication time	6 min	red	3
V11/V21	Pause time	6 hrs	blue	6	V13/V23	Pause time	24 min	blue	6
	Lubrication time	24 s	red	3		Lubrication time	24 s	red	3

4.13 Possible settings of the lubrication and pause times of pumps with control PCB V10-V23

Position of the rotary switch (blue)	1	2	3	4	5	6	7	8	9	A	B	C	D	E	F
Pause time in minutes ⁹⁾	4	8	12	16	20	24	28	32	36	40	44	48	52	56	60
Pause time in hours ⁹⁾	1	2	3	4	5	6	7	8	9	10	11	12	13	14	15

Position of the rotary switch (red)	1	2	3	4	5	6	7	8	9	A	B	C	D	E	F
Lubrication time in seconds ⁹⁾	8	16	24	32	40	48	56	64	72	80	88	96	104	112	120
Lubrication time in minutes ⁹⁾	2	4	6	8	10	12	14	16	18	20	22	24	26	28	30

⁹⁾ Time values for pause and lubrication times are factory-set via the rotary switches and jumpers on the control PCB. The positions of the jumpers must not be changed by the owner.



Note regarding position "0" of the rotary switches

Never turn the rotary switches into position "0". This position is intended exclusively for the owner's purposes. In the "0" position the pump operates with the factory settings and a fault is indicated by the control PCB's right LED.

4.14 Type identification code

The type identification code facilitates selection/ identification of important features of the product. For the type identification code of the respective product, see the type identification plate on the pump.

P	2	0	3	X	D	-	1	1	X	L	B	0	-	6	0	0	-	2	4	-	C	A	0	0	0	0	0	0	-	V	1	3	A	+	A	D	R	Example
A				B C			D		E			F			G		H K		H K		H K		H K		H K		L		M		N		Category					
											1	2	3					X1	X2	X3	X4					Position												

A Product designation¹⁰⁾
P203
B Corrosion protection classes¹⁰⁾
_ = C3 Term of protection ≥ 15 years ¹¹⁾
X = C5-M Term of protection ≥ 15 years ¹¹⁾
C Conformity¹⁰⁾
_ = CE/UKCA
E = CE/UKCA + E1 (ECE R10) approvals
D = CE/UKCA + E1 + UL/CSA approvals
D Reservoir sizes¹⁰⁾
2 = 2 l [0.53 gal.]
4 = 4 l [1.06 gal.]
8 = 8 l [2.11 gal.]
11 = 11 l [2.90 gal.]
15 = 15 l [3.96 gal.]

E Reservoir versions¹⁰⁾
XN = Lubrication grease without low-level indication
XL = Lubrication grease with intermittent low-level indication (NO)
XC = Lubrication grease with intermittent low-level indication (NC)
XNFL = Lubrication grease without low-level indication (flat reservoir)
XNBO = Lubrication grease without low-level indication with reservoir lid
XLBO = Lubrication grease with intermittent low-level indication (NO) and reservoir lid
XNBA = Lubrication grease without low-level indication with lockable reservoir lid
XLBA = Lubrication grease with intermittent low-level indication (NO) and lockable reservoir lid
XBF = Lubrication grease with follower plate, high- and low-level indication
XPF = Lubrication grease with follower plate, high- and low-level indication and pre-warning
XCBO = Lubrication grease with intermittent low-level indication (NC) and reservoir lid
YNBO ¹²⁾ = Lubrication oil without low-level indication with reservoir lid
YLB0 ¹²⁾ = Lubrication oil with float magnetic switch, low-level indication and reservoir lid
YLBA ¹²⁾ = Lubrication oil with float magnetic switch, low-level indication and lockable reservoir lid

¹⁰⁾ From these categories only one feature can be selected at a time.
¹¹⁾ The duration of the corrosion protection does not stand for the warranty period
 C5-M versions cannot be combined with pump elements L, R, B and C.
¹²⁾ Reservoirs for lubrication oil cannot be combined with features L, B and C from category (F), nor with features A and S from category (M).

P	2	0	3	X	D	-	1	1	X	L	B	0	-	6	0	0	-	2	4	-	C	A	0	0	0	0	0	0	-	V	1	3	A	+	A	D	R	Example
A				B		C		D		E		F			G		H		K		H		K		H		K		L		M		N		Category			
												1	2	3	X1		X2		X3		X4								Position									

F | Pump elements¹³⁾

0	=	without pump element	Output volume of pump elements, see chapter Nominal output volume
L	=	Piston Ø 5 mm [0.20 in.]	
5	=	Piston Ø 5 mm [0.20 in.]	
6	=	Piston Ø 6 mm [0.23 in.]	
7	=	Piston Ø 7 mm [0.28 in.]	
R	=	Piston Ø 7 mm [0.28 in.]	adjustable output
B	=	Piston Ø 7 mm [0.28 in.]	with bypass
C	=	Piston Ø 7 mm [0.28 in.]	for chisel paste
Thread: Connection M22x1.5 Outlet G1/4			

G | Rated voltage¹⁰⁾

12	=	12 V DC
24	=	24 V DC

Positions of the pump elements in the type identification code

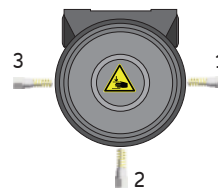

If only 2 pump elements are required, these should be positioned oppositely to one another (positions 1 and 3).

¹³⁾ From these categories there is always required a multiple selection with indication of the position.

P	2	0	3	X	D	-	1	1	X	L	B	0	-	6	0	0	-	2	4	-	C	A	0	0	0	0	0	0	-	V	1	3	A	+	A	D	R	Example
A				B C			D		E				F			G			H		K	H	K	H	K	H	K		L		M		N				Category	
												1	2	3					X1	X2	X3	X4					Position											

H | Connections types on the pump¹³⁾

O	=	No connection to the pump
A	=	Square plug for V10-V13 PCB (Pins 1 and 2 assigned)
C	=	Square plug for V10-V13 PCB (Pins 1 and 3 assigned)
E	=	Square plug V20-V23 PCB
5	=	Bayonet plug 4/3 poles ¹⁴⁾
R	=	Bayonet plug 7/6 poles ¹⁴⁾
8	=	Screwed cable gland with cable and Deutsch plug
F	=	Square plug - control PCB / signal

Possible positions of the connection types on the pump

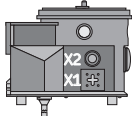
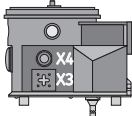
Left side:	Right side:	X1	X2	X3	X4
		A	0	0	0
		A	0	F	0
		C	0	0	0
		C	0	F	0
		E	0	0	0
Example out of the above type identification code: X1 is the position of the square plug (C). X2-X4 are not assigned.		E	0	F	0
		O	5	0	0
		O	R	0	0
		O	8	0	0

K | connection material¹³⁾ ¹⁴⁾

O	=	Without connection material	
1	=	Only connection socket (black)	O A C E
A	=	Connection socket (black) with moulded cable 10 m [33 ft]	O A C E
C	=	Connection socket (black) with fitted ADR cable 10 m [33 ft]	O A C E
E	=	Bayonet socket 4/3-wire LLC with cable 10 m [33 ft]	5
G	=	Bayonet socket 7/6-wire LLC +LDT with cable 10 m [33 ft]	R
2	=	Only connection socket (grey)	F
B	=	Connection socket (grey) with moulded cable 10 m [33 ft]	F
D	=	Connection socket (grey) with fitted ADR cable 10 m [33 ft]	F
L	=	Connection socket (grey) with moulded cable 6 m [20 ft]	F
M	=	Bayonet socket 7/3-wire with cable 6 m [20 ft]	R

Connection material suitable for connection type

Connection material is delivered loosely together with the pump

¹³⁾ From these categories there is always required a multiple selection with indication of the position.

¹⁴⁾ Always select suitable connection material with bayonet socket for connection types 5 and R

P	2	0	3	X	U	-	1	1	X	L	B	0	-	6	0	0	-	2	4	-	C	A	0	0	0	0	0	0	-	V	1	3	A	+	A	D	R	Example
A				B C		D		E			F			G		H K		H K		H K		H K		H K		L		M		N			Category					
													1	2	3					X1	X2	X3	X4					Position										

L Control PCB and factory setting¹⁰⁾																												
V10 = Terminals 15/30 bridged; pause time = 6 h lubrication time = 6 min																												
V11 = Terminals 15/30 bridged; pause time = 6 h lubrication time = 24 sec																												
V12 = Terminals 15/30 bridged; pause time = 24 min lubrication time = 6 min																												
V13 = Terminals 15/30 bridged; pause time = 24 min lubrication time = 24 sec																												
V20 = Pause time = 6 h lubrication time = 6 min																												
V21 = Pause time = 6 h lubrication time = 24 sec																												
V22 = Pause time = 24 min lubrication time = 24 sec																												
V23 = Pause time = 24 min lubrication time = 24 sec																												
M Lubrication grease¹⁰⁾																												
A ¹⁵⁾ = Pump factory-filled with Fuchs Renocal FN 745																												
S ¹⁶⁾ = Pump factory-filled with lubricant as specified by customer																												
Z = w/o lubrication grease																												
N additional indications¹⁰⁾																												
ADR ¹⁷⁾ = Pump for hazardous material transporters																												
A = Adapter with lubrication fitting and NPT thread																												
A+SV = Pressure control valve including adapter with 1/8" NPT thread																												

Observe the note regarding "Terminals 15/30 bridged" in chapter "Changing the lubrication and pause times via jumper setting".

¹⁵⁾ Pumps are filled with the following grease quantities. Pump without follower plate; 2L reservoir approx. 750 g [27 fl.oz.] ≥ 4L reservoir approx. 1500 g [54 fl.oz.]; pump with follower plate: approx. 2250 g [81 fl.oz.].

¹⁶⁾ Observe the restrictions regarding CLP / GHS in chapter Safety instructions as well as the lubricant specifications indicated in chapter Technical Data.

¹⁷⁾ Always select the additional indication ADR together with characteristics C and D from category (K).

5. Delivery, returns, and storage

5.1 Delivery

After receipt of the shipment, check the shipment for damage and completeness according to the shipping documents. Immediately report any transport damages to the forwarding agent.

Keep the packaging material until any discrepancies are resolved. During in-house transport ensure safe handling.

5.2 Returns

Clean all contaminated parts before returning them. If this is not possible or if it does not make sense, e. g. for the troubleshooting in case of a complaint, make sure to indicate the pumped material.

In case of products contaminated with hazardous substances according to GHS respectively CLP regulations, also send the corresponding safety data sheet (SDS) and mark the packaging accordingly.

The choice of packaging depends on the specific product and the expected loads during transport (e.g. mechanical impacts, necessary corrosion protection measures in case of sea transport).

In case of wooden packaging observe the respective import regulations and IPPC

standards. Add the required certificates to the shipping documents.

Mark returns on the packaging at least as follows.



5.3 Storage

SKF products are subject to the following storage conditions:

- dry, dust- and vibration-free in closed premises
- no corrosive, aggressive materials at the place of storage (e. g. UV rays, ozone)
- protected against pests and animals (insects, rodents, etc.)
- possibly in the original product packaging
- shielded from nearby sources of heat and coldness
- in case of high temperature fluctuations or high humidity take adequate measures (e. g. heater) to prevent the formation of condensation water



Before application inspect the products with regard to possible damages occurred during their storage. This particularly applies for parts made out of plastic (embrittlement).

5.4 Storage temperature range

- In case of parts not filled with lubricant the admissible storage temperature corresponds to that of the admissible ambient temperature of the pump (see Technical data)
- In case of parts filled with lubricant the admissible storage temperature range is:

min. + 5 °C [+41 °F]
 max. + 35 °C [+95 °F]



If the storage temperature range is not adhered to, the following work steps for replacing the lubricant may not in all cases lead to the desired result.

5.5 Storage conditions for parts filled with lubricant

The conditions mentioned in the following will have to be adhered to when storing products filled with lubricant,

5.5.1 Storage period of up to 6 months

The filled products can be used without having to take further measures.

5.5.2 Storage period from 6 to 18 months

Pump

- Connect the pump electrically
- Switch the pump on and let it run, e.g. by triggering an additional lubrication cycle, until about 4 cc of lubricant will leak from each pump element
- Switch the pump off and disconnect it from the electrical grid
- Remove and dispose of leaked lubricant

Metering device

- Remove all connection lines and closure screws, if any
- Connect the pump primed with new lubrication grease suitable for the application purpose to the divider bar in such way that the opposite port of the divider bar remains open
- Let the pump run until new lubricant leaks from the divider bar
- Remove leaked lubricant
- Reinstall closure screws and connection lines

Lines

- Dismantle preassembled lines
- Ensure that both line ends remain open
- Prime lines with new lubricant

5.5.3 Storage period exceeding 18 months

To avoid dysfunctions consult the manufacturer before commissioning. The general procedure to remove the old grease filling corresponds to that of a storage period from 6 to 18 months.

6. Installation

6.1 General information

Only qualified technical personnel may install the products described in these Instructions.

During assembly pay attention to the following:

- Other units must not be damaged by the assembly
 - The product must not be installed within the range of moving parts
 - The product must be installed at an adequate distance from sources of heat and coldness
 - Observe the product's IP degree of protection
 - Adhere to safety distances and legal prescriptions on assembly and prevention of accidents
- Possibly existing visual monitoring devices, e.g. pressure gauges, MIN/MAX markings or piston detectors, must be clearly visible
 - Observe prescriptions in chapter Technical data regarding the installation position

6.2 Place of installation

Protect the product against humidity, dust and vibrations and install it in an easily accessible position to facilitate other installation and maintenance works.

6.3 Mechanical connection

6.3.1 Minimum assembly dimensions

Ensure sufficient space for maintenance work or for attachment of further components to build a centralized lubrication system to the pump by leaving a free space of at least 100 mm [3.94 in.] into each direction in addition to the stated dimensions.

Reservoir version	Reservoir size ~ Height (H) mm [in.]					Reservoir size ~ Width (W) mm [in.]					Reservoir size ~ Depth (D) mm [in.]				
	2	4	8	11	15	2	4	8	11	15	2	4	8	11	15
litre															
gal.	[0.53]	[1.06]	[2.11]	[2.90]	[3.96]	[0.53]	[1.06]	[2.11]	[2.90]	[3.96]	[0.53]	[1.06]	[2.11]	[2.90]	[3.96]
XN	325	355	458		708	213	230	250		240	224	250	250		244
	[12.79]	[13.98]	[18.03]		[27.87]	[8.39]	[9.06]	[9.84]		[9.45]	[8.81]	[9.84]	[9.84]		[9.60]
XNFL	244					232					250				
	[9.61]					[9.13]					[9.84]				
XNBO	360	350	457	611	729	211	232	232	227	216	224	250	250	224	244
	[14.17]	[13.78]	[18]	[24.06]	[28.7]	[8.30]	[9.13]	[9.13]	[8.93]	[8.50]	[8.82]	[9.84]	[9.84]	[8.82]	[9.61]
XNBA		360	467				250	230				250	251		
		[14.17]	[18.36]				[9.84]	[9.06]				[9.84]	[9.88]		
XL	330	355	465		729	213	230	230		230	224	250	250		250
	[13]	[13.98]	[18.30]		[28.70]	[8.30]	[9.06]	[9.06]		[9.06]	[8.82]	[9.84]	[9.84]		[9.84]
XLBO	360	355	457	618	730	213	250	230	220	220	224	250	251	250	244
	[14.17]	[13.98]	[17.99]	[24.33]	[28.74]	[8.30]	[9.84]	[9.06]	[8.66]	[8.66]	[8.82]	[9.84]	[9.88]	[9.84]	[9.61]
XLBA		365	467				250	230				250	251		
		[14.37]	[18.39]				[9.84]	[9.06]				[9.84]	[9.88]		
XC	325	355	458			213	230	250			224	250	250		
	[12.80]	[13.98]	[18.03]			[8.30]	[9.06]	[9.06]			[8.82]	[9.84]	[9.84]		

Reservoir version	Reservoir size ~ Height (H) mm [in.]					Reservoir size ~ Width (W) mm [in.]					Reservoir size ~ Depth (D) mm [in.]				
	2	4	8	11	15	2	4	8	11	15	2	4	8	11	15
litre															
gal.	[0.53]	[1.06]	[2.11]	[2.90]	[3.96]	[0.53]	[1.06]	[2.11]	[2.90]	[3.96]	[0.53]	[1.06]	[2.11]	[2.90]	[3.96]
XCBO	360	380	482	618	730	213	250	230	220	220	224	250	251	250	244
	[14.17]	[14.96]	[18.97]	[24.33]	[28.74]	[8.30]	[9.84]	[9.06]	[8.66]	[8.66]	[8.82]	[9.84]	[9.88]	[9.84]	[9.61]
XBF		408	498	611	785		232	251	227	227		250	260	244	244
		[16.06]	[19.61]	[24.06]	[30.91]		[9.13]	[9.88]	[8.94]	[8.93]		[9.84]	[10.24]	[9.61]	[9.61]
XPF			498		785			498		785			260		244
			[19.61]		[30.91]			[19.61]		[30.91]			[10.24]		[9.61]
YNBO	360	350	457		729	211	232	232		216	224	250	250		244
	[14.17]	[13.78]	[18]		[28.7]	[8.30]	[9.13]	[9.13]		[8.50]	[8.82]	[9.84]	[9.84]		[9.61]
YLBO	360	398	510		785	213	250	250		227	224	250	250		244
	[14.17]	[15.67]	[20.08]		[30.91]	[8.30]	[9.84]	[9.84]		[8.93]	[8.82]	[9.84]	[9.84]		[9.61]
YLBA			500					250					250		
			[19.69]					[9.84]					[9.84]		

Minimum assembly dimensions Fig. 6

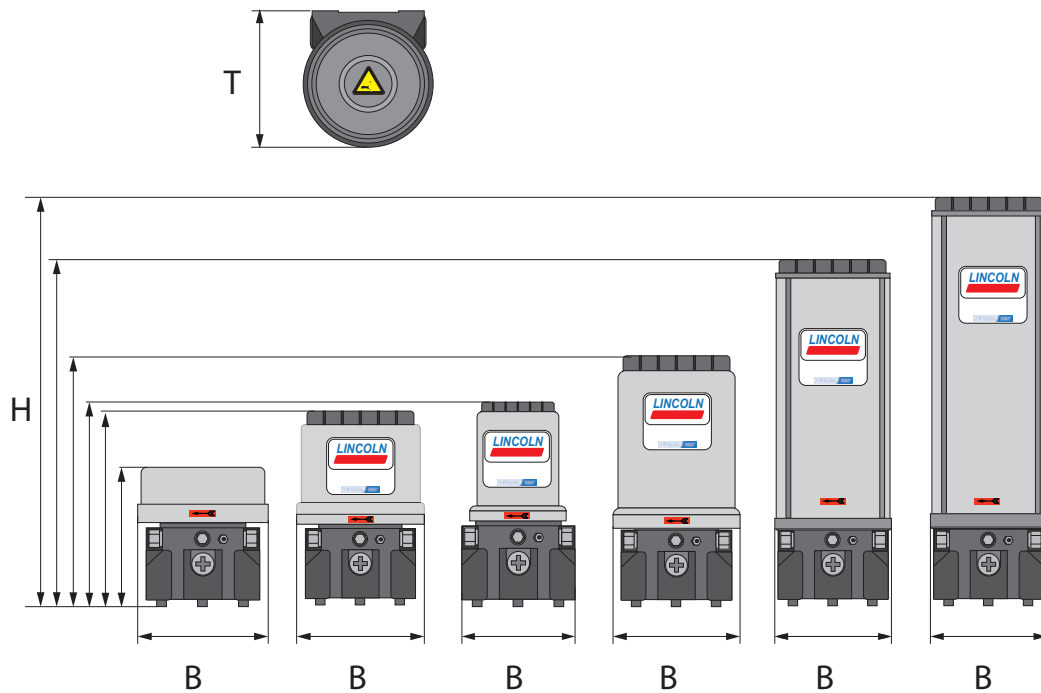

6.3.2 Installation bores

NOTICE**Risk of damage to the superior machine and to the pump**

Drill the mounting bores on non-load-bearing parts of the superior machine only. Fastening must not be done on two parts moving against one another (e. g. machine bed and machine assembly). When assembling pumps with 11l [2.9 gal.] or 15l [3.96 gal.] reservoirs the flatness of the upper and the lower mounting surfaces may deviate by a maximum of 1 mm [0.039 in.] from each other.

Fastening is done by means of:

2 resp. 3 screws	M8 (8.8)
2 resp. 3 hexagon nuts	M8 (8.8)
2 resp. 3 washers	8

Tightening torque = 18 Nm \pm 1.0 Nm
[13.27 ft.lb. \pm 0.74 ft.lb.]

Diameter of bores in the pump housing = \varnothing 9 mm [0.35 in.]

Pumps with 2 l [0.53 gal.] reservoir
Are fixed at the two lower fastening points (A) or (B) of the pump housing.

A1	=	162 mm	[6.38 in.]
B1	=	180 mm	[7.09 in.]
A2	=	124 mm	[4.88 in.]
B2	=	112 mm	[4.41 in.]

Pumps 2l Flat [0.53gal.] 4l [1.06gal.],
8 l [2.11 gal.], 11l [2.90 gal.] and 15l
[3.96 gal.] reservoir

Are fixed at the three lower fastening points (A) or (B) and (C) of the pump housing.

C1	=	83 mm	[3.27 in.]
C2	=	95 mm	[3.74 in.]

Fastening points at the P203 pump housing Fig. 7

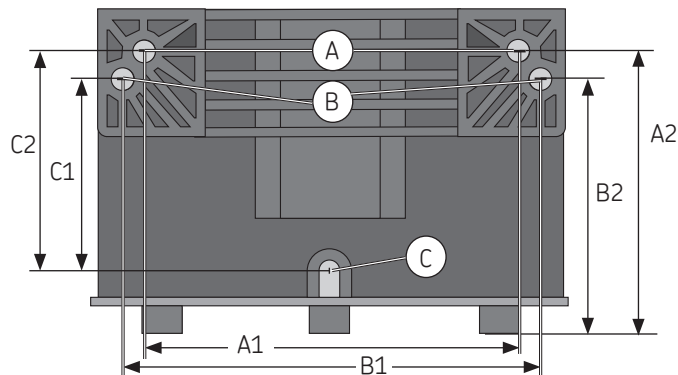

Pumps with 11 l [2.9 gal.] or 15 l [3.96 gal.] reservoir

Are fixed on the lower mounting bores (A) or (B) and (C) of the pump housing and additionally on the 2 upper mounting points (D).



Fastening (A) and (B), see previous Figure.

Fastening on top on the fixing angle by means of:

2 screws	M8 (8.8)
2 hexagon nuts	M8 (8.8)
2 washers	8

Tightening torque = 18 Nm \pm 1.0 Nm
[13.27 ft.lb. \pm 0.74 ft.lb.]

Diameter of the bores at the upper fixing angle = \emptyset 10.4 mm [10 in.].

Reservoir 11l [2.90 gal.]

D1 =	557 mm [21.93 in.]
D2 =	160 mm [6.30 in.]
D3 =	80 mm [3.15 in.]

Reservoir 15 l [3.96 gal.]

D1 =	675 mm [26.57 in.]
D2 =	160 mm [6.30 in.]
D3 =	80 mm [3.15 in.]

Mounting bores for pumps with 11 l [2.9 gal.] or 15 l [3.96 gal.] reservoir Fig. 8

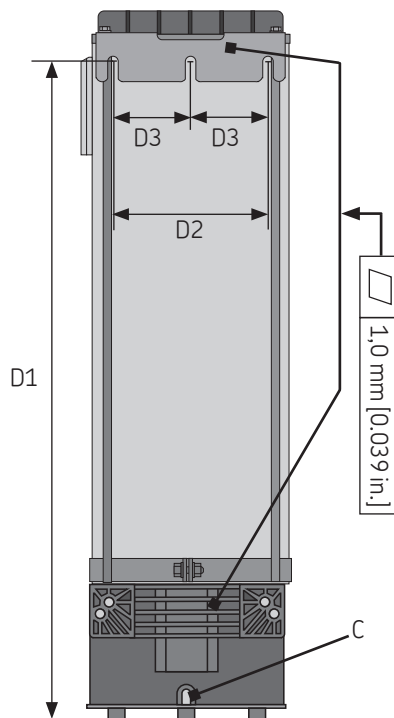

6.4 Electrical connection

**WARNING****Electric shock**

Make sure to disconnect the product from the power supply before carrying out any works on electrical components.

Carry out the electrical connection according to the connection type of the pump,

- Tailor the line for the power supply (5.1) according to the respective connection diagram in these instructions or use pre-fabricated cable (see type identification code)
- Insert bushing into corresponding plug and tighten respectively in case of square plugs tighten with its screw. Only be doing so the degree of protection can be complied with



Connect the line in such way that no mechanical forces are transferred to the product.



Electrical connection, Fig. 9

Types of connections

Square plug
DIN EN 175301-803



Bayonet plug
ISO 15170-1

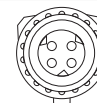
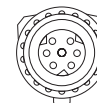

The electrical connection of the low-level indication (5.3) of pumps with follower plate is made according to the pump's connection type. See chapter Connection of the signal line to the reservoir lid

Electrical connection of the low-level indication of pumps with follower plate Fig. 10



6.5 Adjusting the output volume on the pump element R



The output of pump element R can be adjusted only while the pump is idle. Factory setting is full supply, i.e. The adjusting measure is $S = 29 \text{ mm}$ [1.14 in.].

To set the output volume proceed as follows:

- Loosen the counter nut (3.2)
- Adjust the output volume by screwing the spindle (3.3) to the indicated measure according to the table on the right

↻ = lower output volume

↻ = higher output volume

- After adjusting the output volume, retighten the counternut (3.2)

Tightening torque = $20 \text{ Nm} \pm 2.0 \text{ Nm}$
[14.75 ft.lb. \pm 1.4 ft.lb.]

Adjusting the output volume on pump element R Fig. 11

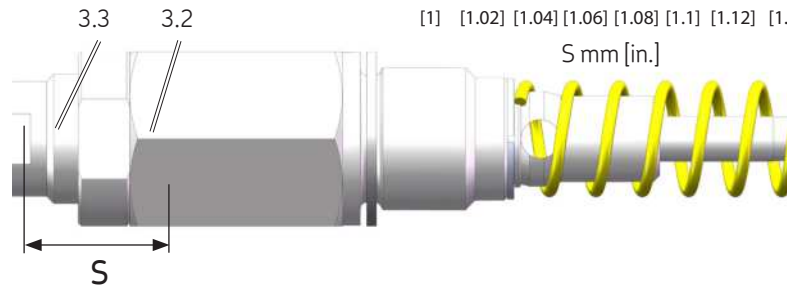
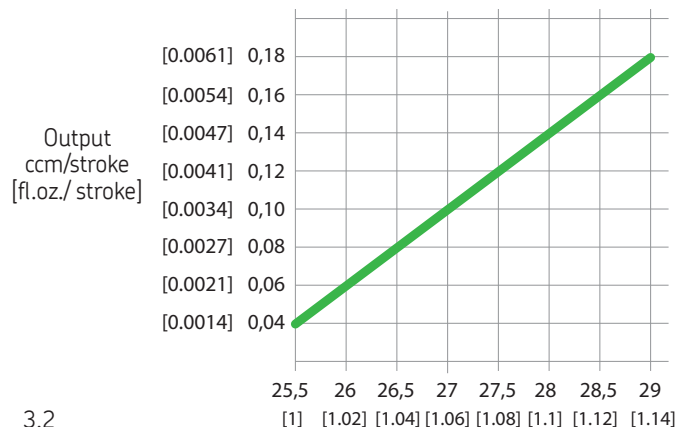

6.6 Mount pressure control valve

Protect each pump element by means of a pressure control valve suitable for the planned maximum admissible operating pressure of the centralized lubrication system.



Observe the information given in chapter 4 regarding the adapter required for certain reservoir sizes.

To carry out the assembly proceed as follows:



- Remove the closure plug (3.1) from the pump element (3)
- Screw pressure control valve (8) into pump element (3)
- Repeat procedure for each pump element

Tightening torque = 6 Nm -0.5 Nm
[4.43 ft.lb. - 0.07 ft.lb.]

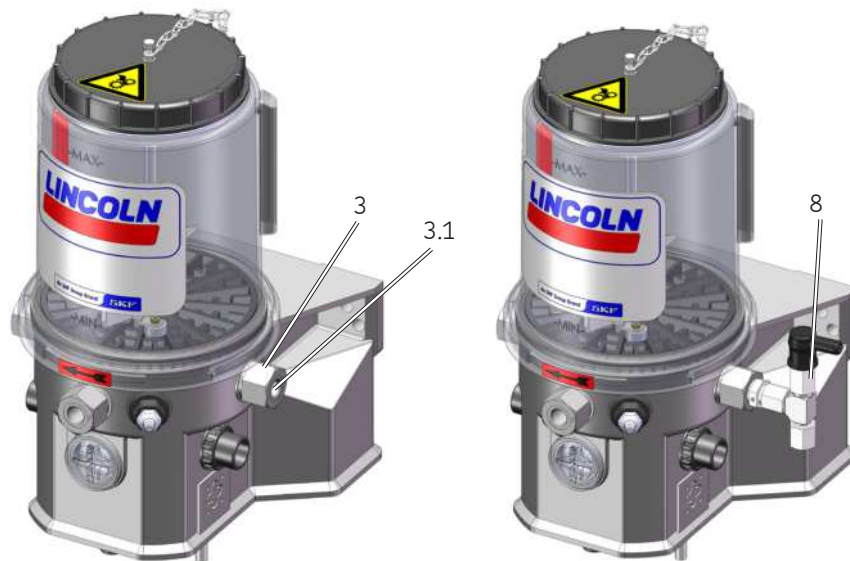
Mounting the pressure control valve Fig. 12



6.7 Lubrication line connection

 CAUTION
 <p>Risk of falling Exercise care when dealing with lubricants. Bind and remove spilled or leaked lubricants immediately.</p>



Connect lubrication lines in such way that no forces are transferred to the product (tension-free connection).

All components of the centralized lubrication system must be laid out for:

- the maximum arising operating pressure
- the admissible ambient temperature
- the output volume and the lubricant to be supplied

Observe the following installation instructions for safe and smooth operation.

- Use clean components and filled lubrication lines only
- The main lubrication line should be laid preferably rising with a possibility to vent it at its highest point. Lubrication lines shall generally be laid in such way that there can never be created air pockets at any point
- Possibly mount the lubricant metering devices at the end of the main lubrication line in such way that the outlets of the lubricant metering devices show upwards
- If lubricant metering devices have to be mounted below the main lubrication line, then this should not be done at the end of the main lubrication line

- The lubricant flow should not be impeded by the installation of sharp elbows, angle valves, gaskets protruding to the inside, or cross-section changes (big to small). Provide unavoidable changes of the cross sections in the lubrication lines with as smooth transitions as possible

6.8 Filling with lubricant

6.8.1 Filling via the reservoir lid

WARNING



Crushing hazard

on the rotating stirring paddle. Filling via the reservoir lid is allowed only after disconnecting the pump from the power supply by removing it from the connection (5.1).

- Unscrew the reservoir lid (1.1) anti-clockwise from the reservoir. Deposit the reservoir lid at a clean place. The inside of the reservoir lid must not be contaminated. Remove possible contaminations
- Fill the reservoir from the top up to the MAX marking. Make sure to fill in the lubricant without air inclusions, if possible
- Reinstall the reservoir lid (1.1) clockwise

Filling via the reservoir lid Fig. 13

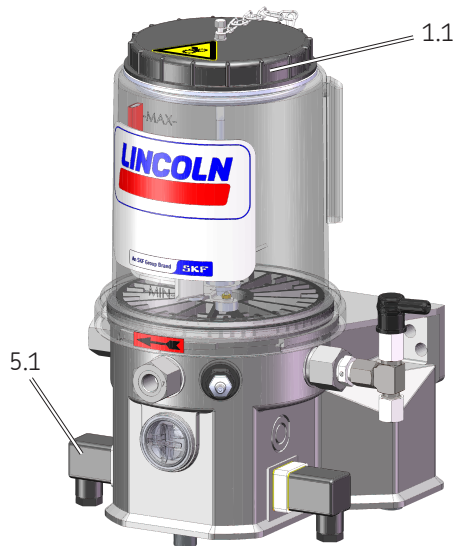

6.8.2 Filling via filler fitting

- Switch the pump on and let it run during the filling procedure
- Connect filling connection of filler pump with filler fitting (4)
- Switch on filler pump and fill reservoir until shortly below the MAX marking
- Switch filler pump off and remove it from filler fitting (4) of pump
- Switch the pump off.

Filling via filler fitting Fig. 14

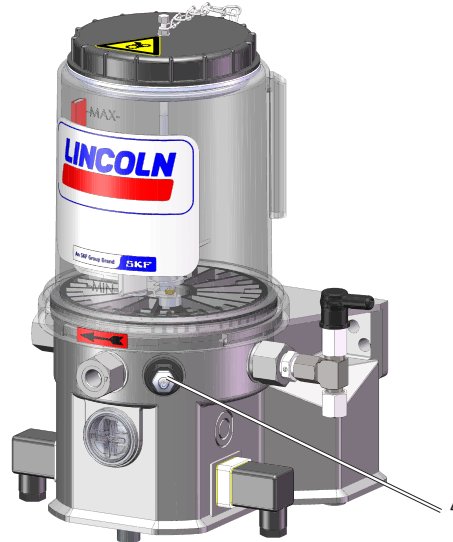

6.8.3 Filling via the optional filling connection

- Switch the pump on and let it run during the filling procedure
- Unscrew protective cap (20.1) from filling connection (20) anticlockwise
- Connect filling connection of filler pump with filler fitting (20)
- Switch on filler pump and fill reservoir until shortly below the MAX marking
- Switch off filler pump and remove it from filler fitting (20) of pump
- Screw protective cap (20.1) clockwise onto filling connection (20) of pump again
- Switch the pump off.

Filling via optional filling connection Fig. 15

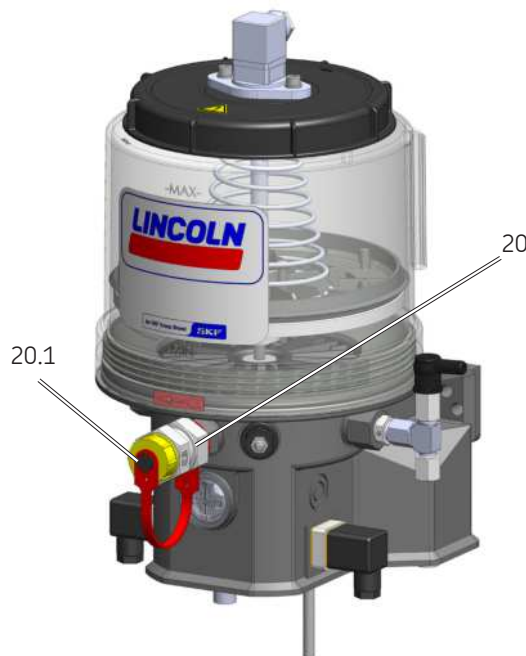

6.8.4 Initial filling of an empty pump with follower plate

In case of pumps without grease filling, before commissioning the space below the follower plate must be filled with grease. Any further fillings take place only via the filler fitting (4) or the optional filling connection on the pump



CAUTION



Spring force

Slowly loosen the reservoir lid holding it well. Wear safety goggles.

- Unscrew the reservoir lid (1.1) anti-clockwise from the reservoir
- Carefully loosen (6.1) the spring from the fixation at the follower plate (6)
- Carefully pull the contact rod (6.2) out of the follower plate (6)
- Remove the reservoir lid together with the spring and the contact rod

Initial filling of an empty pump with follower plate Fig. 16

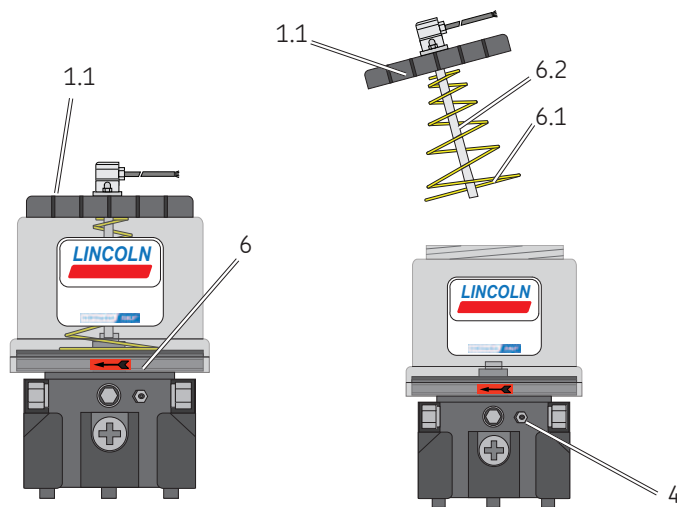

- Lightly oil the reservoir inside and the sealing lip of the follower plate
- Slightly tilt the follower plate (6) in the reservoir so that the side opposite of the filler fitting (4) is at the highest point
- At this point pass a cable tie (13) into the area below the follower plate as shown
- Position the follower plate (6) horizontally again. When doing so ensure that the cable tie (13) creates an air gap.
- Position the filling connection (14) of the filler pump onto the filler fitting and fill the space below the follower plate with lubricant. Ensure that no air pockets remain below the follower plate and that no lubricant reaches the upper side of the follower plate
- Remove the cable tie (13)

Initial filling of an empty pump with follower plate Fig. 17

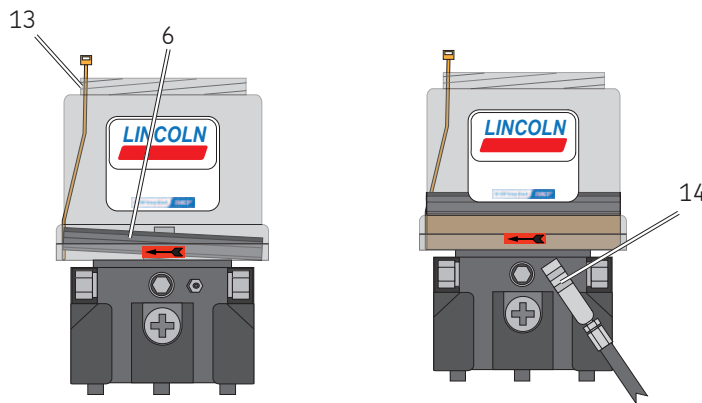

- Reinstall the spring (6.1) and the contact rod
- Close the reservoir lid (1.1) clockwise
- Fill the pump via the filler fitting up to the MAX marking.

Initial filling of an empty pump with follower plate Fig. 18

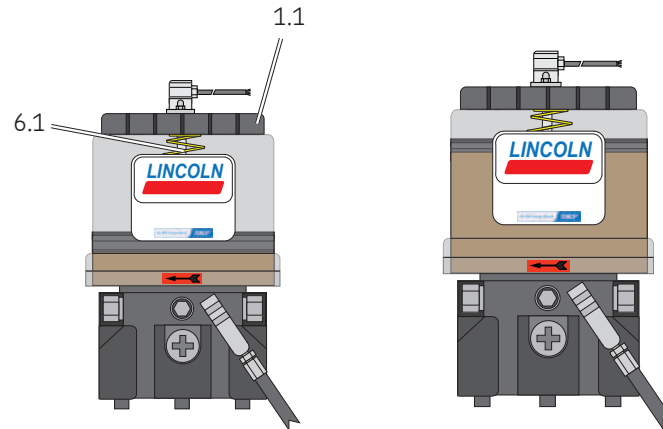

6.9 Setting of lubrication and pause times

Lubrication and pause times are set via the two rotary switches on the control PCB.

- Remove screw cap (9) including sealing ring
- Set the pause time by turning the left blue rotary switch (11.1)
- Set the lubrication time by turning the right red rotary switch (11.2)
- Mount screw cap (9) with gasket again

Tightening torque $2 \text{ Nm} \pm 0.2 \text{ Nm}$
[1.48 ft.lb. \pm 0.15 ft.lb.]



Do not turn the rotary switches in the "0" position. In the "0" position the pump operates with the factory settings and a fault is indicated by the control PCB's right LED.

Setting of lubrication and pause times Fig. 19

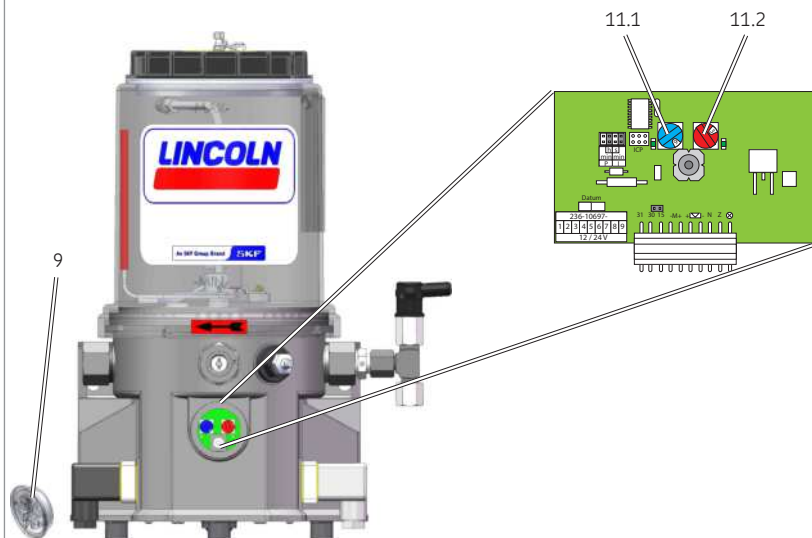

6.10 Changing the lubrication and pause times via jumper setting

NOTICE

Damage to the superior machine
 Jumper positions on the control PCB should never be changed. Changed jumper positions cannot be easily recognized by other persons and may therefore result in wrong settings of the lubrication and pause times.

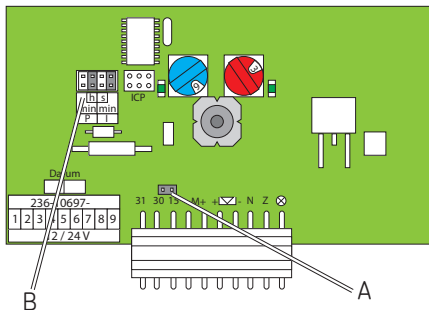

Jumper position for bridge Terminals 15/30	Control PCB	Pause time		Lubrication time		Jumper position on the control PCB	
		4 - 60 min.	1/15 h	8-120 s	2-30 min		
A	V 10						
not bridged	V 20		X		X	B	
A	V 11			X		B	
not bridged	V 21		X	X		B	
A	V 12					B	
not bridged	V 22	X			X	B	
A	V 13					B	
not bridged	V 23	X		X		B	
		= Jumper positioned					
* If terminal 15 (machine contact/ drive switch) is bridged with terminal 30 (+) and if voltage is present at terminal 30, then the pump can work without the superior machine/ vehicle having to run. Without bridge the pump works only, if also the superior machine/ vehicle runs.							

7. Initial start-up

In order to warrant safety and function, a person assigned by the operator must carry out the following inspections. Immediately eliminate detected deficiencies. Deficiencies may be remedied by an authorized and qualified specialist only.

		Start-up check list	
7.1 Inspections prior to initial start-up		YES	NO
Electrical connection carried out correctly		<input type="checkbox"/>	<input type="checkbox"/>
Mechanical connection carried out correctly		<input type="checkbox"/>	<input type="checkbox"/>
The performance data of the previously indicated connections correspond to the specifications stated in the Technical data		<input type="checkbox"/>	<input type="checkbox"/>
All components, such as lubrication lines and metering devices, have been correctly installed		<input type="checkbox"/>	<input type="checkbox"/>
Product protected with adequate pressure control valve		<input type="checkbox"/>	<input type="checkbox"/>
No visible damage, contamination and corrosion		<input type="checkbox"/>	<input type="checkbox"/>
Any dismantled protection and monitoring equipment has been reassembled and checked for correct function		<input type="checkbox"/>	<input type="checkbox"/>
All warning labels on the product are available and in proper condition		<input type="checkbox"/>	<input type="checkbox"/>
The lubrication and pause times adjusted on the control PCB correspond to the planned lubrication and pause times		<input type="checkbox"/>	<input type="checkbox"/>
7.2 Inspections during initial start-up			
No unusual noises, vibrations, accumulation of moisture, or odours present		<input type="checkbox"/>	<input type="checkbox"/>
No unwanted escape of lubricant (leakages) from connections		<input type="checkbox"/>	<input type="checkbox"/>
Lubricant is supplied free from bubbles		<input type="checkbox"/>	<input type="checkbox"/>
Bearings and friction points are provided with the planned amount of lubricant		<input type="checkbox"/>	<input type="checkbox"/>

7.3 Acknowledge receipt of a fault indication

To acknowledge receipt of a fault indication proceed as follows:

- Localize fault via flashing frequency and eliminate it
- Remove screw cap (9) including gasket
- Press pushbutton (11.3) on control PCB (< 1 seconds) to acknowledge receipt of a fault. The right LED (11.5) turns off
- Mount screw cap (9) and sealing ring again

Tightening torque $2 \text{ Nm} \pm 0.2 \text{ Nm}$
 $[1.48 \text{ ft.lb.} \pm 0.15 \text{ ft.lb.}]$



A non-acknowledged fault remains stored even after switching off the machine contact/ drive switch, i.e. when switching the pump on again, the LED (11.5) flashes according to the pending fault.

Acknowledging receipt of a fault indication Fig. 20

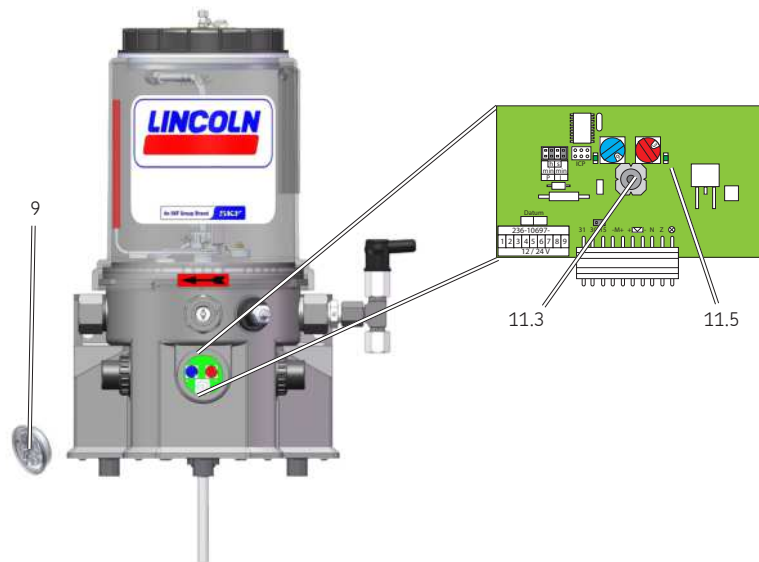

- To start the pump press the pushbutton (11.3) again (> 2 seconds). An additional lubrication will be carried out
- Mount screw cap (9) and gasket again

Tightening torque $2 \text{ Nm} \pm 0.2 \text{ Nm}$
[1.48 ft.lb. \pm 0.15 ft. lb.]

Acknowledging receipt of a fault indication Fig. 21

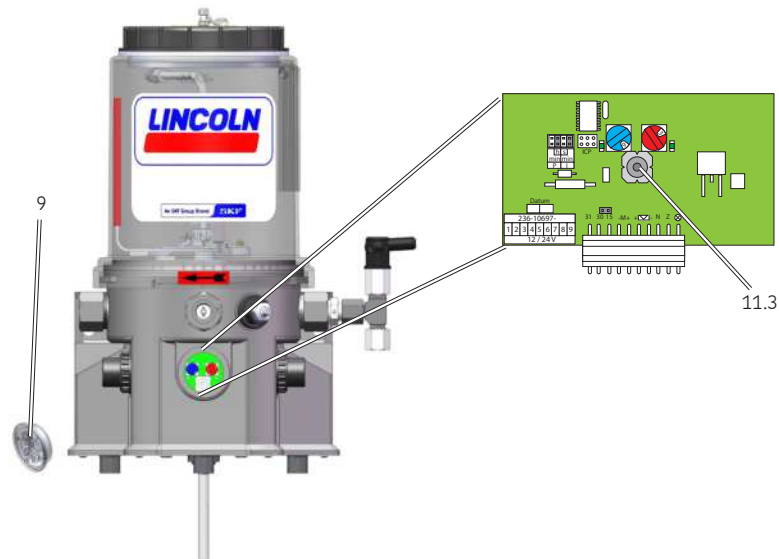

7.4 Triggering an additional lubrication cycle

To trigger an additional lubrication cycle proceed as follows:

- Remove screw cap (9) including sealing ring
- Press the pushbutton (11.3) on the control pcb (> 2 seconds) to trigger an additional lubrication. The right LED (11.5) starts lighting and will continue lighting as long as the motor runs

The pump starts a lubrication cycle. The duration of the lubrication cycle corresponds to the value adjusted on the control PCB.

- Mount screw cap (9) and gasket again

Tightening torque 2 Nm \pm 0.2 Nm
[1.48 ft.lb. \pm 0.15 ft.lb.]

Setting of lubrication and pause times Fig. 22

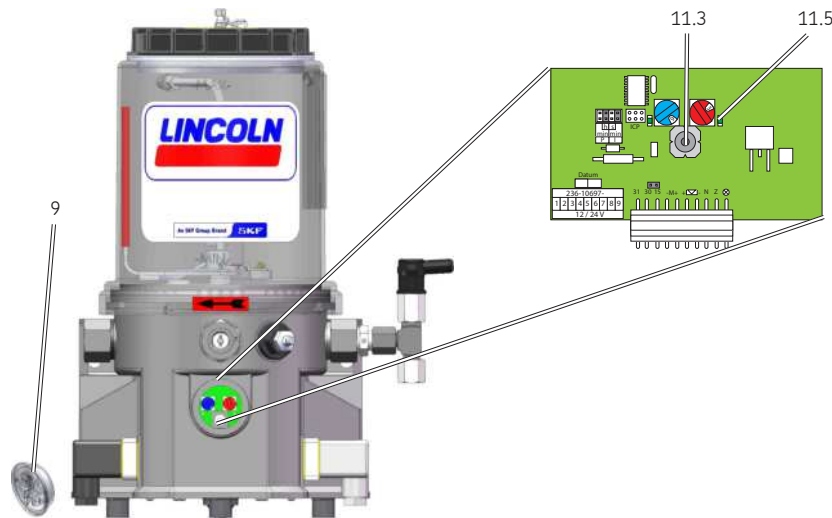

8. Operation



SKF products operate automatically to the greatest possible extent.

Basically, activities during standard operation are limited to the control of the filling level of pumps without low-level indication and the timely refilling of lubricant.

8.1 Refill lubricant

See chapter Filling with lubricant

9. Cleaning

	WARNING
	<p>Electric shock</p> <p>Carry out cleaning works only on depressurized products that have been disconnected from the power supply. Do not touch cables or electrical components with wet or damp hands.</p> <p>Use steam-jet cleaners or high-pressure cleaners only in accordance with the degree of protection of the pump. Otherwise electrical components may be damaged.</p> <p>Performance of cleaning, required personal protective equipment, cleaning agents and devices following the valid operational regulations of the operator.</p>

9.1 Cleaning agents

Cleaning agents compatible with the material may be used only. (Materials, see chapter 2.3).



Thoroughly remove residues of cleaning agents from the product and rinse off with clear water.

9.2 Exterior cleaning

- Mark and secure wet areas
- Keep unauthorized persons away
- Thorough cleaning of all outer surfaces with a damp cloth



Make sure to keep the reservoir closed during the cleaning procedure.

9.3 Interior cleaning

Normally, interior cleaning is not required. Should incorrect or contaminated lubricant have been filled, inside cleaning of the product will be required.

To do so, contact the SKF Customer Service.

10. Maintenance

Regular and appropriate maintenance is a prerequisite to detect and clear faults in time. The specific time lines have to be determined, verified at regular intervals and adapted, if necessary, by the operator based on the operating conditions. If needed, copy the table for regular maintenance activities.

Maintenance check list		
Activity to be done	YES	NO
Electrical connection carried out correctly	<input type="checkbox"/>	<input type="checkbox"/>
Mechanical connection carried out correctly	<input type="checkbox"/>	<input type="checkbox"/>
The performance data of the previously indicated connections correspond to the specifications stated in the Technical data	<input type="checkbox"/>	<input type="checkbox"/>
All components, such as lubrication lines and metering devices, have been correctly installed	<input type="checkbox"/>	<input type="checkbox"/>
Product protected with adequate pressure control valve	<input type="checkbox"/>	<input type="checkbox"/>
No visible damage, contamination and corrosion	<input type="checkbox"/>	<input type="checkbox"/>
Any dismantled protection and monitoring equipment has been reassembled and checked for correct function	<input type="checkbox"/>	<input type="checkbox"/>
All warning labels on the product are available and in proper condition	<input type="checkbox"/>	<input type="checkbox"/>
No unusual noises, vibrations, accumulation of moisture, or odours present	<input type="checkbox"/>	<input type="checkbox"/>
No unwanted escape of lubricant (leakages) from connections	<input type="checkbox"/>	<input type="checkbox"/>
Lubricant is supplied free from bubbles	<input type="checkbox"/>	<input type="checkbox"/>
Bearings and friction points are provided with the planned amount of lubricant	<input type="checkbox"/>	<input type="checkbox"/>

11. Troubleshooting

Fault table 1

Fault	Possible cause	Remedy
Pump does not run	Power supply to pump interrupted <ul style="list-style-type: none"> - Superior machine is switched off - Connection cable of pump is loose or defective - External fuse is defective Pump is in the pause time mode Pump motor is defective Pump control PCB or power supply board is defective Internal cable break	Check whether one of the indicated faults is present and remedy it in the frame of responsibilities. Faults outside of your own responsibility have to be reported to your superior to initiate further measures. If the fault cannot be determined and remedied, please contact our Customer Service.
Pump runs but supplies no or only little lubricant	Blockade, fault within the centralized lubrication system Defective check valve Defective pressure relief valve Suction bore of pump element is clogged Close pump element Air pockets in the lubricant/ under the follower plate Too high lubricant consistency (at low temperatures) Too low lubricant consistency (at high temperatures) Wrong configuration of metering device within the centralized lubrication system	Check whether one of the indicated faults is present and remedy it in the frame of responsibilities. Faults outside of your own responsibility have to be reported to your superior to initiate further measures. If the fault cannot be determined and remedied, please contact our Customer Service.

10

11

11.1 Display of the operating states and fault conditions by means of the control PCB's LEDs

Particular operating states and fault conditions are displayed via the control PCB's LEDs.

LED display	Possible cause			Remedy
Both LEDs off	A	F	G	Switch on operating voltage; change defective control PCB
Left LED is lit permanently	B			No fault, normal operating state (pause time)
Both LEDs are lit permanently	C			No fault, normal operating state (lubrication time)
Right LED flashes at an interval of four	D			Turn rotary switch out of position "0"
Right LED flashes at an interval of three	E			Replace control PCB

Possible cause

- A No (adequate) operating voltage (terminal 15)
- B Operating voltage (terminal 15) is present
- C Motor is running
- D Rotary switch in position "0"
- E Short circuit on pushbutton
- F Control PCB defective
- G Internal cable break

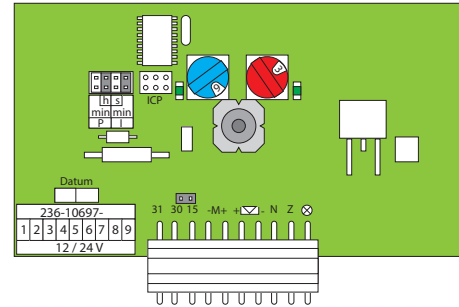

12. Repairs



WARNING



Risk of injury

Before carrying out any repair work, take at least the following safety measures:



o Keep unauthorized persons away

o Mark and secure work area

o De-pressurize the product



o Disconnect the product from the power supply and secure it against being switched on

o Verify that no power is being applied

o Earth and short-circuit the product

o Where needed, cover neighbouring units that are live

12.1 Replace pump element and pressure control valve



The characteristics of the new pump element must correspond to the characteristics of the pump element to be replaced.

To replace the pump element, proceed as follows:

- Unscrew defective pump element (3) at its hexagon out of pump housing together with pressure control valve
- Screw the new pump element (3) into the pump housing together with a new gasket

Tightening torque = 20 Nm \pm 2.0 Nm
[14.75 ft.lb. \pm 1.4 ft.lb.]

- Then screw a new pressure control valve (8) into the pump element

Tightening torque = 6 Nm \pm 0.5 Nm
[4.43 ft.lb. \pm 0.07 ft.lb.]

Replace pump element Fig. 23



12.2 Replacement of the control PCB

The work should possibly be done at room temperature. At low temperatures the replacement may be subject to restrictions. To facilitate replacement of the control PCB the pump should be tilted into horizontal position.

To replace the control PCB proceed as follows:

- Check the new control PCB for accordance with the documentation and the intended purpose
- Take protection measures against electrostatic discharge
- Unscrew the screws (2.2) from the housing cover (2.1)
- Remove housing cover (2.1)
- Remove plug (11.7) from control PCB and pull control PCB (11) out of the two lateral guide rails

Unscrew housing cover Fig. 24

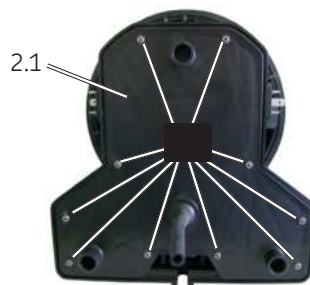

Control PCB removed Fig. 26

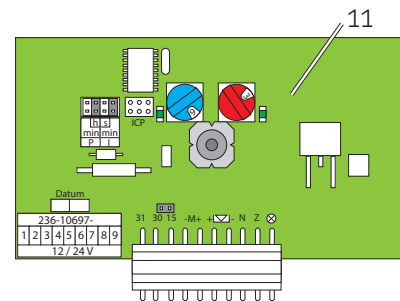

Plug of the control PCB Fig. 25



- Note down any changed jumper positions and rotary switch positions and apply them to the new control PCB
- Place control PCB into lateral guide rails and carefully press it down
- Reinsert plug (11.7)
- Guide the drain hose (12) from rear through the housing cover (2) until it safely engages in the housing cover (2.1) with its notch (12.1)
- Position housing cover (2.1) on pump housing again and retighten with screws (2.2)

Tightening torque = $0.6 \text{ Nm} \pm 0.1 \text{ Nm}$
 $[0.44 \text{ ft.lb.} \pm 0.01 \text{ ft.lb.}]$

11.3 Installation of the pump at the place of use

Installation and start-up at the place of use shall be carried out as described in chapter Installation.

Mount drain hose Fig. 27

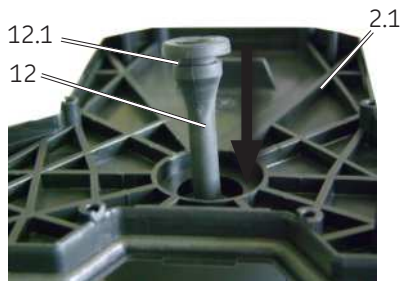

Mount housing cover Fig. 29

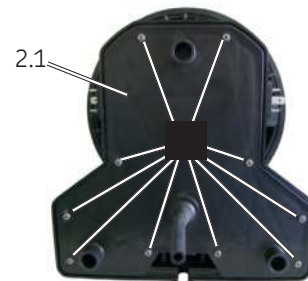

Plug of the control PCB Fig. 28



12.4 Tests after replacement of the control PCB



After replacement of the control PCB carry out an electrical safety test according to EN 60204-1.

Filing

After the replacement of the control PCB the scope and findings of the test have to be recorded in writing and handed over for filing to the person responsible for machine operation.

13. Shutdown and disposal

13.1 Temporary shutdown

Temporarily shut the system down by:

- Switching off the superior machine
- Disconnecting the product from the power supply

13.2 Final shutdown and disassembly

The final shutdown and disassembly of the product must be planned and carried out by the operator in a professional manner and in compliance with all regulations to be observed.

13.3 Disposal

Countries within the European Union

Disposal should be avoided or minimized wherever possible. Disposal of products contaminated with lubricant must be effected via licensed waste disposal contractor in accordance with environmental requirements and waste disposal regulations as well as local authority requirements.



The specific classification of the waste is in the waste producer's responsibility, as the European Waste Catalogue provides different waste disposal codes for the same type of waste but of different origin.

Electrical components

have to be disposed of or recycled following WEEE directive 2012/19/EU.

Plastic or metal parts

can be disposed of with the commercial waste.

Countries outside the European Union

The disposal has to be done according to the valid national regulations and laws of the country where the product is used.

14. Spare parts

The spare parts assemblies may be used exclusively for replacement of identical defective parts. Modifications with spare parts on existing products are not allowed. Exceptions to this are the pump elements and the optional filling connection.

14.1 Housing cover Assy.

Designation	Qty.	Part number
Housing cover Assy.	1	544-32217-1
Housing cover Assy. for pumps with UL approval	1	544-60207-1

Delivery including drain hose and the corresponding number of screws required for installation

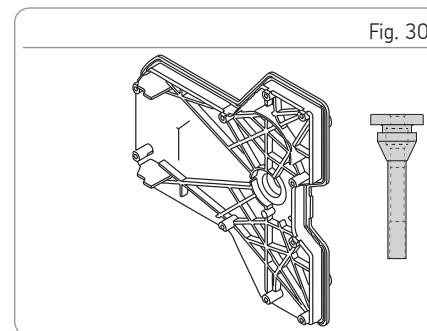

14.2 Pump elements

Designation	Qty.	Part number C3 version	Part number C5-M version
Pump element L including gasket	1	600-78018-1	Not available
Pump element 5 including gasket	1	600-26875-2	600-29303-1
Pump element 6 including gasket	1	600-26876-2	600-29304-1
Pump element 7 including gasket	1	600-26877-2	600-29305-1
Pump element R including gasket	1	655-28716-1	Not available
Pump element B including gasket	1	600-29185-1	Not available
Pump element C including gasket	1	600-28750-1	Not available

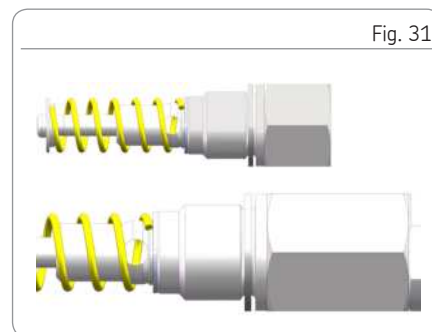

14.3 Pressure control valve and adapter

Designation	Qty.	Part number
Pressure control valve SVTS-350-R 1/4-D6 C3	1	624-28894-1
Pressure control valve SVTS-350-R 1/4-D6 C5-M	1	624-29343-1
Pressure control valve SVET-350-G 1/4 A-D8 C3	1	624-29054-1
Pressure control valve SVTSV-270-R1/4-1/8NPTFI-NIP00R-A C3	1	270864
Adapter S2520 1/4 -1/4 with PTFE sealing	1	226-14105-5



Further pressure control valves in C3 and C5-M on request

14.4 Adapter D 6 AX 1/8NPT | C

Designation	Qty.	Part number
Adapter for pressure control valve 270864 C3	1	304-19614-1

14.5 Motor 12/ 24 V DC

Designation	Qty.	Part number
Motor 12 V DC	1	544-36913-6
Power supply 24 V DC	1	544-36913-7

Delivery including 1 x motor connection for control PCB; 2 x O-ring 142 x 4; 3 x O-ring 6 x 2; 1 x radial shaft seal; 3 x screw M6 x 25 self-tapping; 3 x washer; 1 x spring washer; 1 x housing cover with drain hose and corresponding number of screws for installation

Fig. 32



Fig. 33

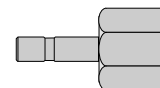
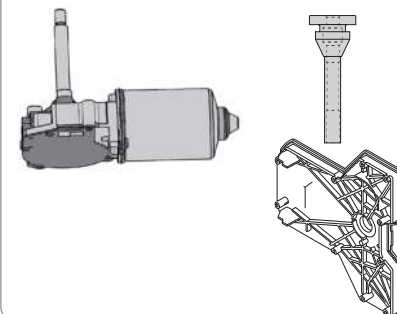

Fig. 34



14.6 Magnetic switch normally open (NO)

Designation	Qty.	Part number
Magnetic switch normally open (NO) for intermittent low-level indication	1	544-60277-1
Magnetic switch normally closed (NC) for intermittent low-level indication	1	5440-00000039

Delivering including housing cover, drain hose, and the corresponding number of screws required for installation

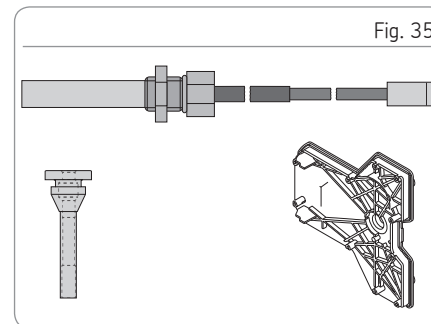

Fig. 35

14.7 Adapter with lubrication fitting

Designation	Qty.	Part number
Adapter with lubrication fitting ST 1/4 NPTF including gasket	1	519-33840-1
Adapter with lubrication fitting A2 AR 1/4 including gasket	1	519-33959-1
Adapter with lubrication fitting ST AR 1/4 including gasket	1	519-33955-1

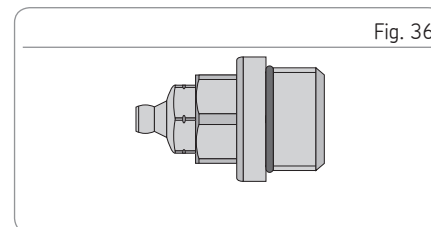

Fig. 36

14.8 Closure screw M22 x 1,5

Designation	Qty.	Part number
Closure screw M22x 1,5 including gasket	1	519-60445-1

Serves to close an unneeded outlet, e.g. if a pump element is removed.

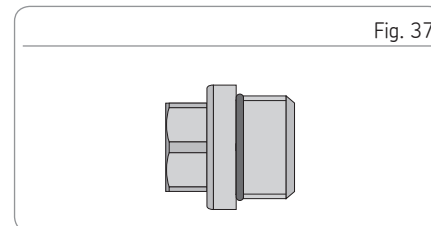

Fig. 37

14.9 Transparent reservoir

Designation	Qty.	Part number
2 l XNFL ^{B,C}	1	544-31997-1
2 l XN ^{A,B,C}	1	544-31996-1
2 l XL (with stirring paddle) ^{A,B,C}	1	544-32028-1
2 l XN/YNBO ^{A,B,C,D,E}	1	544-31940-1
2 l XLBO (without stirring paddle) ^{A,B,C,D,E} (Fig. similar 544-31940-1)	1	544-32027-1
4 l XNBO/YNBO/XLBO/YLBO/XBFA ^{B,C}	1	544-31998-1
4 l XN/XLA ^{B,C,F}	1	544-32695-1
8 l XNBO/YNBO/XLBO/YLBO/XBFA ^{B,C}	1	544-31999-1
8 l XN/XLA ^{B,C,F}	1	544-32696-1

Delivery including: A = Lincoln/SKF Logo, B = Directional arrow, C = O-Ring, D = Reservoir lid, E = Warning label "Crushing hazard", F = Reservoir lid screwed to reservoir non detachably



Other transparent reservoirs on request

Fig. 38

544-31997-1



544-31996-1



544-32028-1

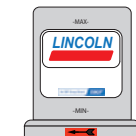

544-31940-1



544-31998-1



544-32695-1



544-31999-1



544-32696-1



14.10 Replacement kit control PCB

Designation	Qty.	Part number
Replacement kit control PCB V1x P203	1	544-60217-1
Replacement kit control PCB V2x P203	1	544-60218-1

Delivering including housing cover, drain hose, and the corresponding number of screws required for installation

Fig. 39

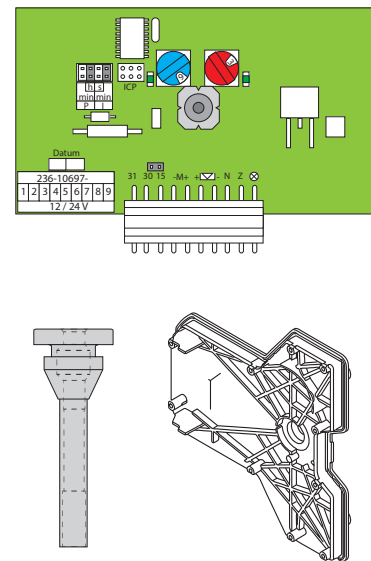

14.11 Fixed paddle

Designation	Qty.	Part number
Fixed paddle 4 XNBO	1	444-70490-1
Fixed paddle 8 XNBO	1	444-70491-1

Fig. 40

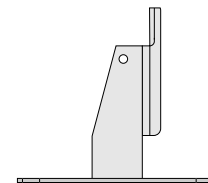
**14.13 Reservoir lid**

Designation	Qty.	Part number
A) Reservoir lid 4/8l [1.06/2.11 gal.] XNBA/XLBA	1	544-36963-1
B) Reservoir lid 4/8l [1.06/2.11 gal.]	1	544-31992-1
C) Reservoir lid 2l [0,53 gal] XNBO	1	544-85156-1

Fig. 41

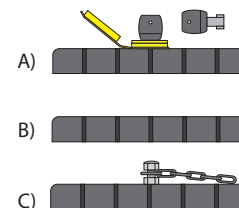
**14.12 Screw cap**

Designation	Qty.	Part number
Screw cap at pump housing	1	544-32851-1

Fig. 42



14.14 Connection sockets and ADR cable

Feature*	Designation	Qty.	Part number
1	Connection socket ^{H)} with gasket and screw	1	544-32850-1
2	Connection socket ^{K)} with gasket and screw	1	544-33843-1
A	Connection cable 10 m [33 ft.] with connection socket ^{H)}	1	664-36078-7
C	Connection cable 10 m [33 ft.] ADR with connection socket ^{H)}	1	664-36862-1
E	Connection cable 10 m [33 ft.] with bayonet socket (7/5 poles)	1	664-34167-2
G	Connection cable 10 m [33 ft.] with bayonet socket (7/7 poles)	1	664-34428-3
M	Connection cable 6 m [33 ft.] with bayonet socket (4/4 poles)	1	664-34167-9
B	Connection cable 10 m [33 ft.] with connection socket ^{K)}	1	664-36078-9
D	Connection cable 10 m [33 ft.] ADR with connection socket ^{H)}	1	664-36862-2
L	Connection cable 6 m (20 ft.) with connection socket ^{H)}	1	664-36862-8

*Feature in type identification code (category K connection material)

H) = black

K) = grey

Feature*	Degree of protection (IEC 60529)
1	IP 65
2	IP 65
A	IP 67
C	IP 65
E	IP 6K9K
G	IP 6K9K
B	IP 67
D	IP 65
L	IP 67

Fig. 43

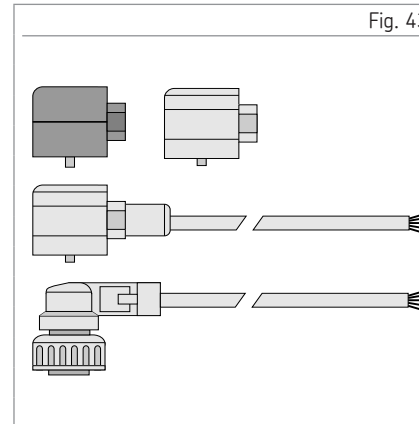

15. Electrical connections

15.1 Cable colours following IEC 60757

Abbreviation	Colour	Abbreviation	Colour	Abbreviation	Colour	Abbreviation	Colour
BK	black	GN	green	WH	white	PK	pink
BN	brown	YE	yellow	OG	orange	TQ	turquoise
BU	blue	RD	red	VT	violet	-----	-----

































The assignment of the following electrical connection diagrams to the actual pump version is done according to the respective referenced type identification code characteristics of the connection diagram. For the complete type identification code of the P203 pumps, see instructions, chapter 4 Technical data.



Not all socket variants are represented in the connection diagrams. For an overview of all available plug variants, see table Overview of cables and connection options.

15.2 Legend

LL	Low-level indication	BG +	Piston detector +	15/MC	Ignition / Machine contact
LLW	Prewarning, empty	BG -	Piston detector -	30	Positive pole / Voltage (battery)
HL	High-level indication	BG S	Piston detector signal	31	Negative pole / Ground (battery)
HLW	Prewarning, high-level signal	P	Pressure switches	54	Brake light voltage (trailers)
HLA	High-level signal, overfull	N	Neutral conductor	PCB	Control printed circuit board
Z	Pushbutton additional lubrication	F	Fuse	n.c.	Not connected
WS	Warning switch filling level	Err	Fault/good signal		
	Pushbutton		Jumper		Mass (housing)
	Light		Fuse		Ground
	Button with light		Load, resistance		Protective earth (PE)
	Piston detector/proximity switch		Low-level indication		Functional earth
	Additional lubrication		Housing		Equipotential bonding
	Battery		Diode		Bluetooth
	Battery disconnecting switch		Light-emitting diode		Antenna
	Customer control unit		Motor AC		Normally open contact (NO)
	Power pack		Motor DC		Normally closed contact (NC)
	Socket		Socket with protective contact		Plug



Not all designations and symbols must be included in every connection diagram. If there are several connection diagrams in an instruction, the assignment to a specific pump variant is made according to the type identification code features indicated in the connection diagram. The type identification code can be found in these instructions in the chapter Technical data. Components and connections shown in the connection diagrams with dashed lines are not part of the scope of delivery of the pump. Components and connections shown in the connection diagrams with dashed-dot lines refer to push-in type connections and to the protective earth conductor.

15.3 Connection of signal line to reservoir lid

Connection diagram of the signal line with the square plug to reservoir lid Fig. 44

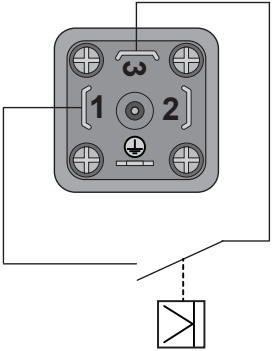
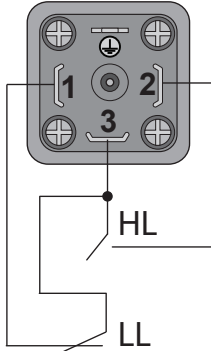
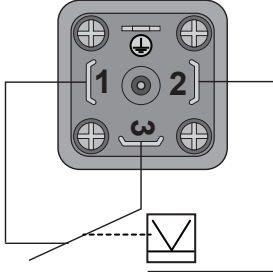
Connection diagram (lubrication grease) Magnetic switch Low-level indication	Connection diagram (lubrication grease) Magnetic switch high- and low-level indication	Connection diagram (lubricating oil) Float magnetic switch Low-level indication			
					
<p>Depiction of unactuated condition</p>					
Maximum switching capacity	21 VA	Maximum switching capacity	21 VA	Maximum switching capacity	60 VA
Maximum switching voltage	30 V DC	Maximum switching voltage	30 V DC	Maximum switching voltage	230 V
Maximum switching current	700 mA	Maximum switching current	700 mA	Maximum switching current	1 A
<p>HL = High level LL = Low level</p>					

15.4 Recommended contact protection measure for switching inductive loads

Recommended contact protection measure for switching inductive loads Fig. 45

For protection of the relay contacts the following contact protection measure should be carried out by the operator.

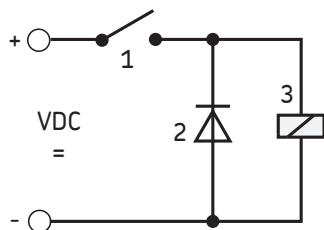

- 1 Magnetic switch
- 2 Interference suppression diode
- 3 Load

15.6 Connection diagram P203 V DC with control PCB V10-V23, 2 of 6

Connection diagram P203 V DC with control PCB V Fig. 47

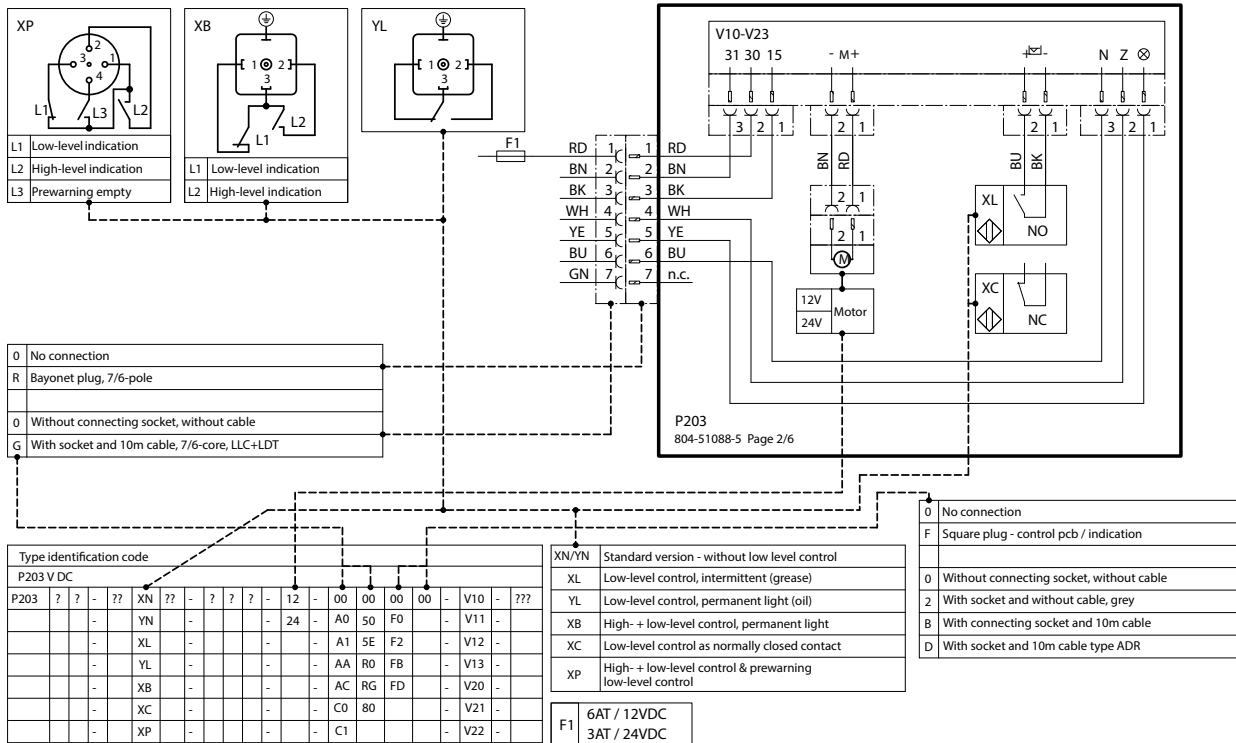

15.7 Connection diagram P203 V DC with control PCB V10-V23, 3 of 6

Connection diagram P203 V DC with control PCB V Fig. 48

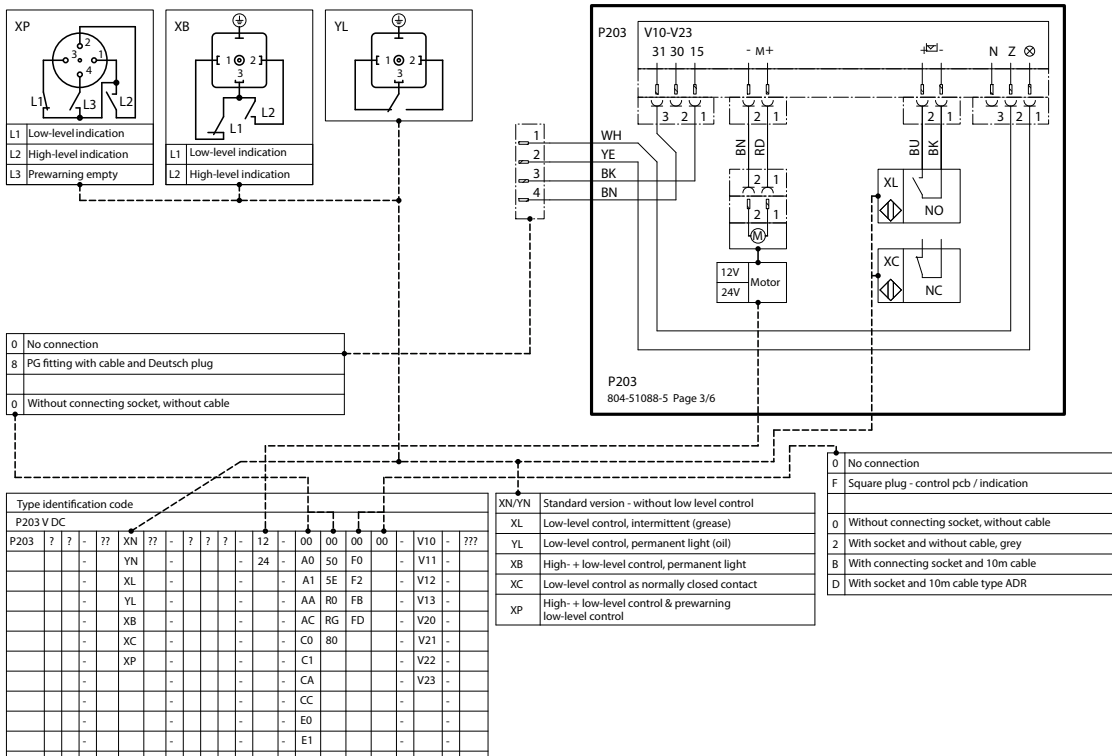

15.8 Connection diagram P203 V DC with control PCB V10-V23, 4 of 6

Connection diagram P203 V DC with control PCB V Fig. 49

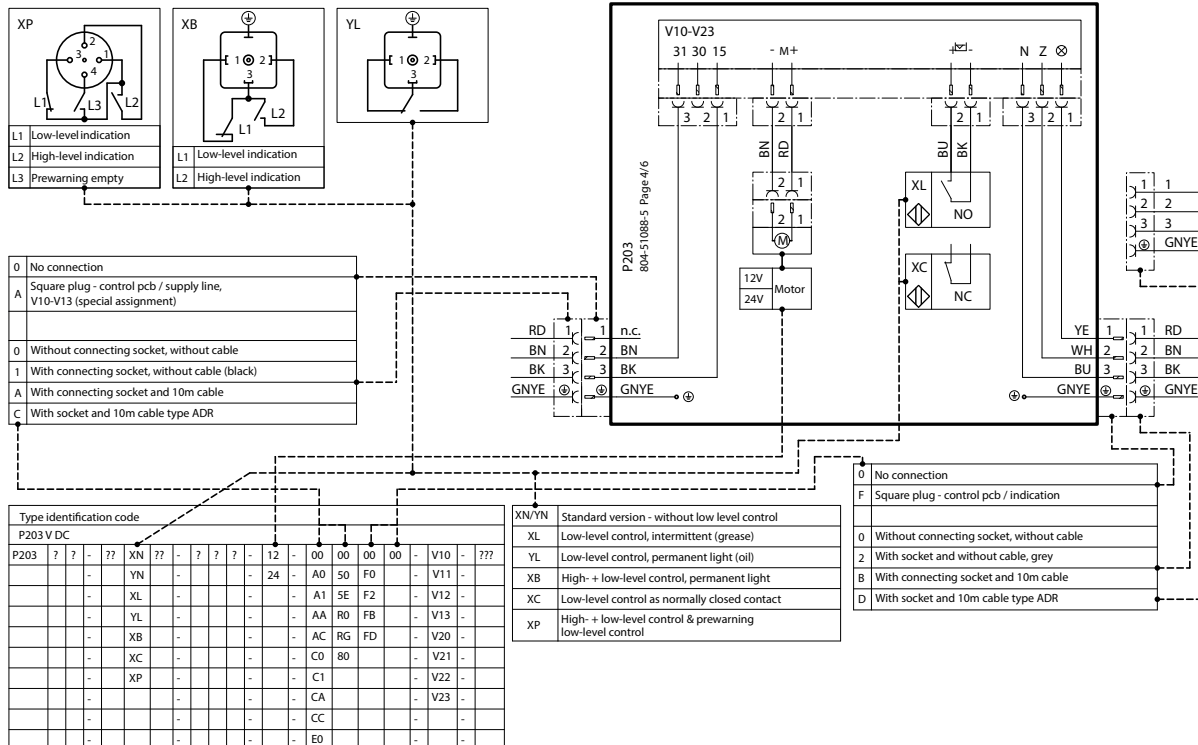

15.9 Connection diagram P203 V DC with control PCB V10-V23, 5 of 6

Connection diagram P203 V DC with control PCB V Fig. 5/0

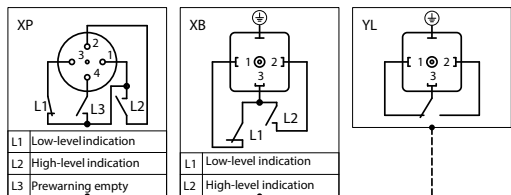

0	No connection
C	Square plug - control pcb / supply line, V10-V13 (standard assignment)
0	Without connecting socket, without cable
1	With connecting socket, without cable (black)
A	With connecting socket and 10m cable
C	With socket and 10m cable type ADR

Type identification code												
P203 V DC												
P203	?	?	-	??	XN	??	-	?	?	?	12	-
					YN						24	-
					XL						A0	S0
					YL						A1	SE
					XB						AA	R0
					XC						AC	RG
					XP						CO	80
											C1	
											CA	
											CC	

XN/YN	Standard version - without low level control
XL	Low-level control, intermittent (grease)
YL	Low-level control, permanent light (oil)
XB	High- + low-level control, permanent light
XC	Low-level control as normally closed contact
XP	High- + low-level control & prewarning low-level control

0	No connection
F	Square plug - control pcb / indication
0	Without connecting socket, without cable
2	With socket and without cable, grey
B	With connecting socket and 10m cable
D	With socket and 10m cable type ADR

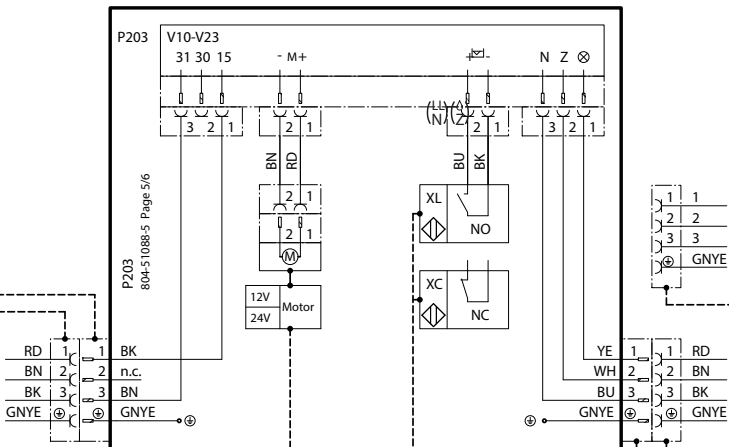



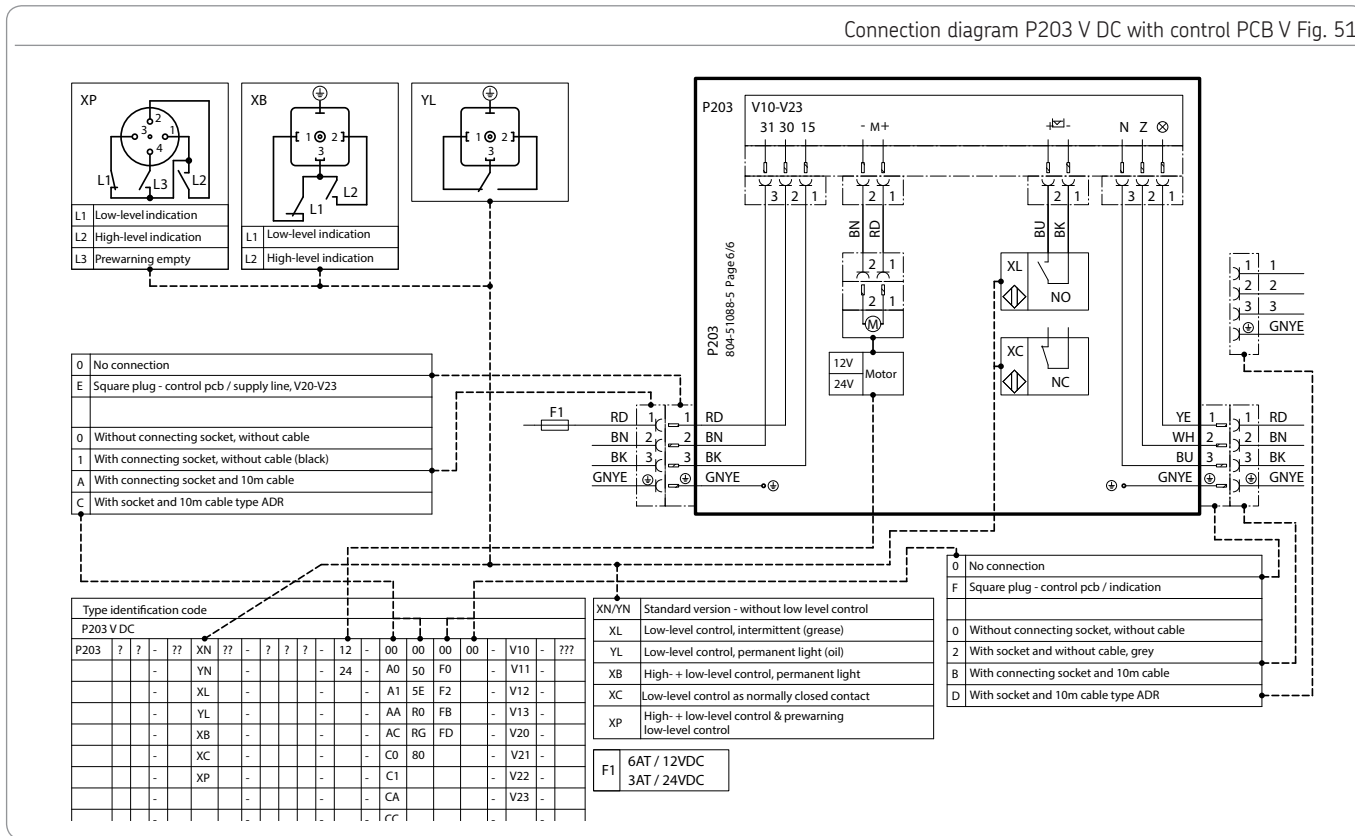

15.10 Connection diagram P203 V DC with control PCB V10-V23, 6 of 6

Connection diagram P203 V DC with control PCB V Fig. 91



15.11 Overview of cables and connection options

Pump						Cable			
External			Internally						
Plug	Colour	P.in	Colour	Function	Polarity	Part number	Length	Cross section	Degree of protection
 Square plug	RD	1	RD	+12/24 VDC	+12/24 VDC	664-36078-7	10 m	4 x AWG 18 4 x 0,82 mm ²	IP67
	BN	2	BN	GND	GND	664-36078-9	10 m		
	BK	3	BK	Counter/Ignition	positive	664-36862-8	6 m		
	GN/YE	PE	GY/YE	PE	PE	664-36862-1	10 m		
						664-36862-2	10 m		
 Bayonet plug, 7-pole	RD	1	RD	+12/24 VDC	+12/24 VDC	664-34428-3	10 m	7 x 1,5 mm ²	IP 6K9K
	BN	2	BN	GND	GND				
	BK	3	BK	Counter/Ignition	positive				
	WH	4	WH	Add Lub(Z)	negative				
	YE	5	YE	NO	negative				
	BU	6	BU	C (max. 30V/4A)	negative				
	GN	7	GN	NC	negative				
 Bayonet 7/5 poles	RD	1	RD	+12/24 VDC	+12/24 VDC	664-34167-2	10 m	3 x 1,5 mm ² (RD, BN, BK) 2 x 0,5 mm ² (WH, YE)	IP 6K9K
	BN	2	BN	GND	GND				
	BK	3	BK	Counter/Ignition	positive				
	WH	4	WH	Add Lub(Z)	negative				
	YE	5	YE	NO/NC	negative				
 Bayonet 4/4 poles	RD/YE	1	RD/YE	+12/24 VDC	+12/24 VDC	664-34167-9	10 m	4 x 0,5 mm ²	IP 6K9K
	BN/YE	2	BN/YE	GND	GND				
	WH/RD	3	WH/RD	Counter/Ignition	positive				
	WH/BN	4	WH/BN	NC	negative				

16. China RoHS Table

部件名称 (Part Name)	有毒害物质或元素 (Hazardous substances)					
	铅	汞	镉	六价铬	多溴联苯	多溴二苯醚
	Lead (Pb)	Mercury (Hg)	Cadmium (Cd)	Hexavalent Chromium (Cr(VI))	Polybrominated biphenyls (PBB)	Polybrominated diphenyl ethers (PBDE)
用钢和黄铜加工的零件 (Components made of machining steel and brass)	X	0	0	0	0	0
本表格依据SJ/T11364的规定编制 (This table is prepared in accordance with the provisions of SJ/T 11364.)						
0 :	表示该有毒有害物质在该部件所有均质材料中的含量均在GB/T 26572 规定的限量要求以下。 (Indicates that said hazardous substance contained in all of the homogeneous materials for this part is below the limit requirement of GB/T 26572.)					
X :	表示该有毒有害物质至少在该部件的某一均质材料中的含量超出GB/T 26572标准规定的限量要求。 (Indicates that said hazardous substance contained in at least one of the homogeneous materials used for this part is above the limit requirement of GB/T 26572.)					

Notes

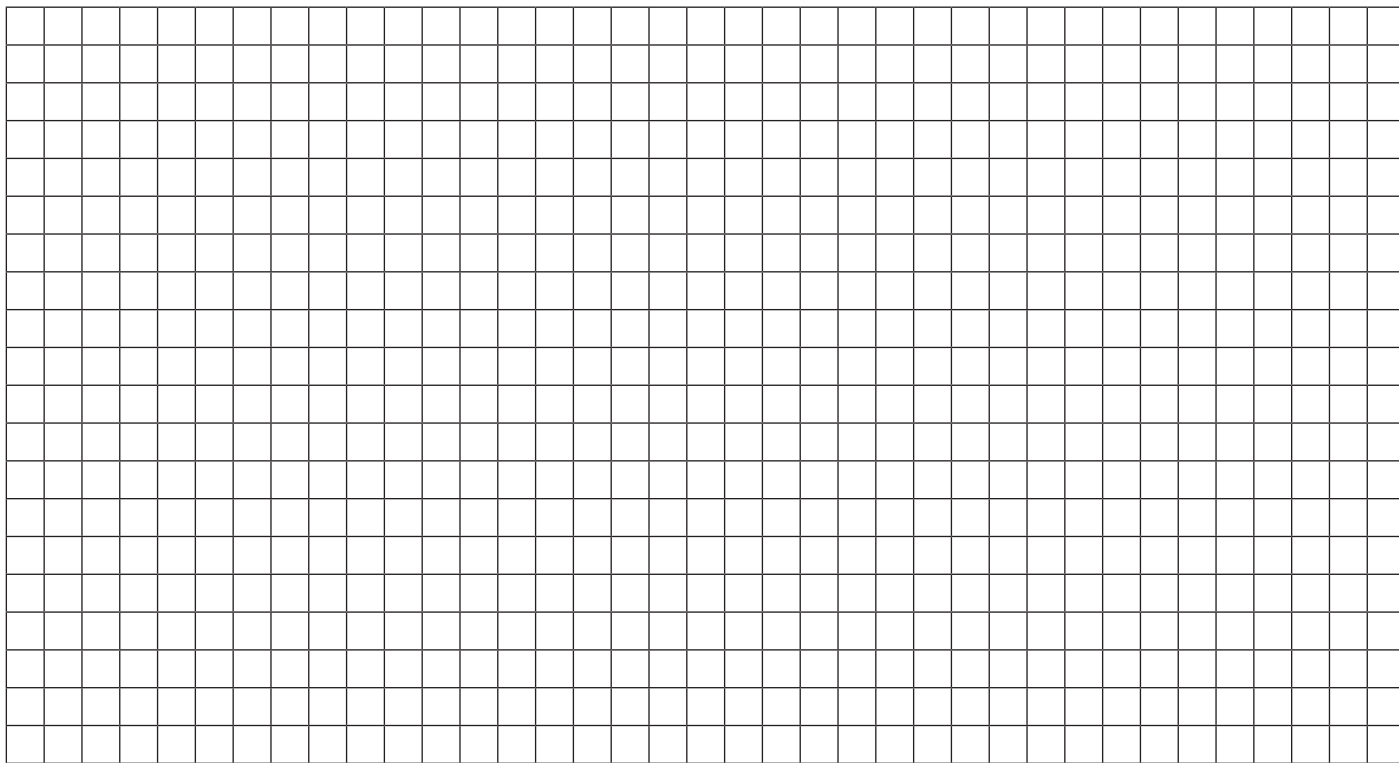

SKF Lubrication Systems Germany GmbH
Walldorf Facilities
Heinrich-Hertz-Straße 2-8
DE - 69190 Walldorf
Phone: +49 (0) 6227 33-0
Fax: +49 (0) 6227 33-259
e-mail: Lubrication-germany@skf.com
www.skf.com/lubrication

951-171-023-EN
Version 02
21/05/2021

